

Outdoor • Day/Night • Weather-proof

IP7330

# NETWORK CAMERA *User's Manual*



## ***Table of Contents***

---

<b><i>Overview</i></b> .....	<b>3</b>
Read Before Use.....	3
Package Contents.....	3
Physical Description.....	4
<b><i>Installation</i></b> .....	<b>6</b>
Hardware Installation.....	6
Network Deployment.....	7
Software Installation.....	10
<b><i>Accessing the Network Camera</i></b> .....	<b>11</b>
Using Web Browsers.....	11
Using RTSP Players.....	13
Using 3GPP-compatible Mobile Devices.....	14
Using VIVOTEK Recording Software.....	15
<b><i>Main Page</i></b> .....	<b>16</b>
<b><i>Client Settings</i></b> .....	<b>19</b>
<b><i>Configuration</i></b> .....	<b>21</b>
System.....	22
Security.....	24
HTTPS.....	25
Network.....	30
DDNS.....	38
Access List.....	40
Video.....	43
Motion Detection.....	49
Camera Tampering Detection.....	52
Application.....	56
Recording.....	69
System Log.....	72
View Parameters.....	73
Maintenance.....	74
<b><i>Appendix</i></b> .....	<b>78</b>
URL Commands for the Network Camera.....	78
Technical Specifications.....	112
Technology License Notice.....	113
Electromagnetic Compatibility (EMC).....	114

## Overview

VIVOTEK IP7330 is a cost-effective, bullet-style network camera designed for our customers' needs in outdoor applications. With its weather-proof IP66-rated housing, the camera is shielded from harsh conditions such as rain and dust and provides an all-in-one solution without the need for additional accessories.

By integrating components for day/night functionality such as dual-band lens and built-in IR illuminators with an effective range of up to 10 meters, the camera is able to achieve superior performance in a compact design. The IP7330 also supports tamper detection, which can detect events such as blockage, redirection, and spray-painting, making it an intelligent solution to possible camera obstruction.

Incorporating a number of VIVOTEK's advanced features, including simultaneous dual streams, dual-codec, 802.3af compliant PoE, and our free standard 16-channel recording software, the IP7330 is the ideal solution for your outdoor surveillance needs.

## Read Before Use

The use of surveillance devices may be prohibited by law in your country. The Network Camera is not only a high-performance web-ready camera but also can be part of a flexible surveillance system. It is the user's responsibility to ensure that the operation of such devices is legal before installing this unit for its intended use.

It is important to first verify that all contents received are complete according to the Package contents listed below. Take notice of the warnings in Quick Installation Guide before the Network Camera is installed; then carefully read and follow the instructions in the Installation chapter to avoid damages due to faulty assembly and installation. This also ensures the product is used properly as intended.

The Network Camera is a network device and its use should be straightforward for those who have basic network knowledge. It is designed for various applications including video sharing, general security/surveillance, etc. The Configuration chapter suggests ways to best utilize the Network Camera and ensure proper operations. For the creative and professional developers, the URL Commands of the Network Camera section serves to be a helpful reference to customize existing homepages or integrating with the current web server.

## Package Contents

- IP7330
- Liquid Tight Connectors (3 holes, for backup use)
- Silica Gel
- Camera Stand
- Power Adapter
- RJ45 Female/Female Coupler
- Quick Installation Guide
- Warranty Card
- Software CD

## Physical Description

### ● Front Panel

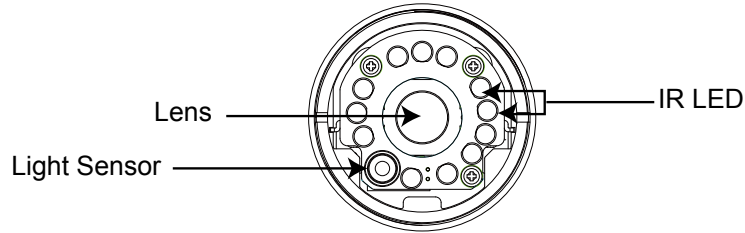

### ● Back Panel

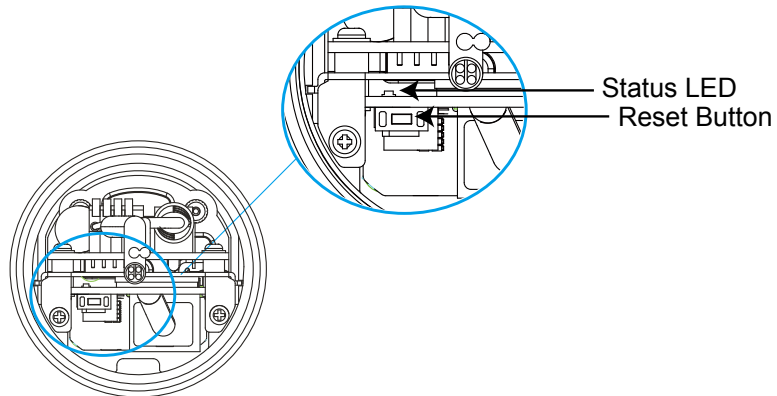

### ● Connectors

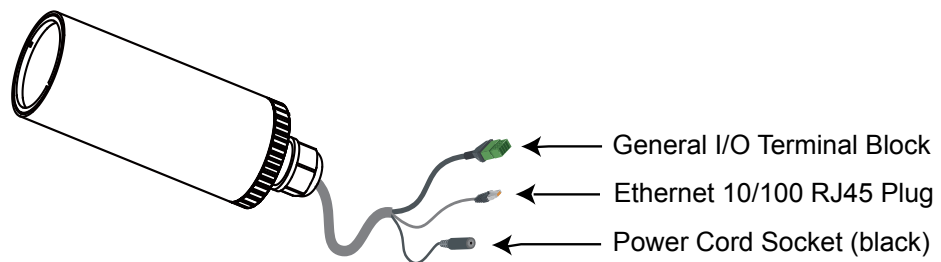

## General I/O Terminal Block

This Network Camera provides a general I/O terminal block which is used to connect external input / output devices. The pin definitions are described below.

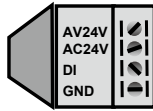

Pin	Name
AV24V	24V+
AC24V	24V-
DI	Digital Input
GND	Ground

## Hardware Reset

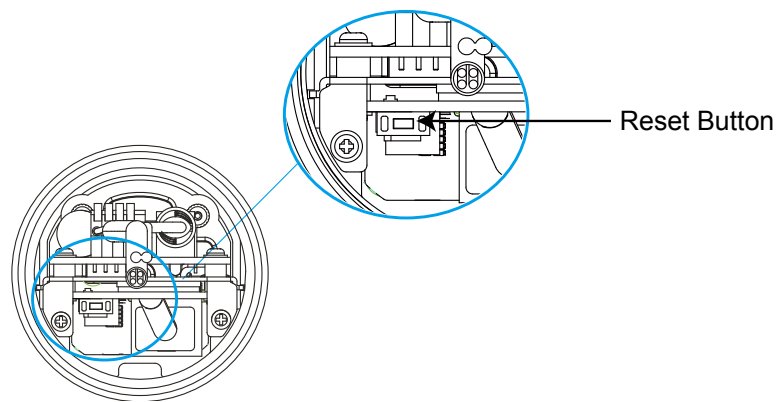

The reset button is used to reset the system or restore the factory default settings. Sometimes resetting the system can return the camera to normal operation. If the system problems remain after reset, restore the factory settings and install again.

**Reset:** Press and release the reset button with a paper clip or thin object. Wait for the Network Camera to reboot.

**Restore:** Press on the reset button continuously for over 5 seconds. Note that all settings will be restored to factory default.

# Installation

## Hardware Installation

1. Loosen the liquid tight connectors, and then remove the rubber.
2. Loosen the back cover.
3. Tear down the aluminum foil vacuum bag and take out the silica gel. Attach the supplied silica gel to the inner side of the Network Camera. (Please replace the silica gel with a new one if you open the back cover after installation.)
4. Make sure all cable lines are securely connected.
5. Tighten the back cover, rubber and liquid tight connectors.
6. Secure the Network Camera to the wall/ceiling by the supplied camera stand.

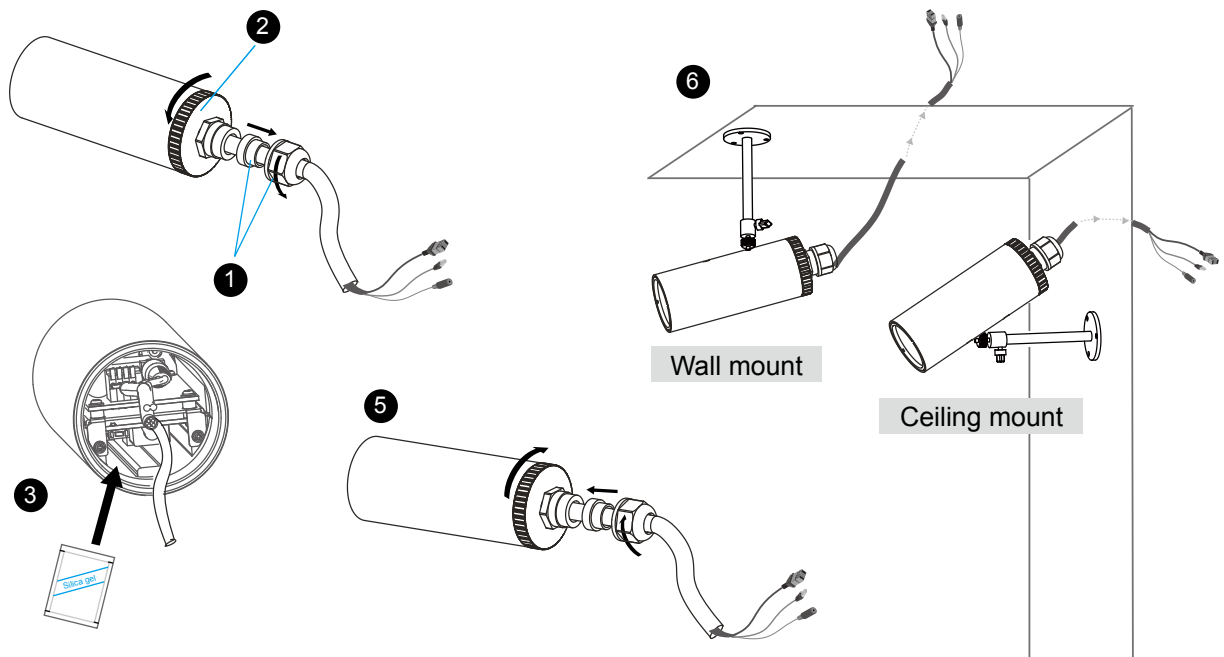

### Note

If you want to use your own cable lines, please loosen two supplied screws and take out the power board. Then be careful to make connections as the illustration below.

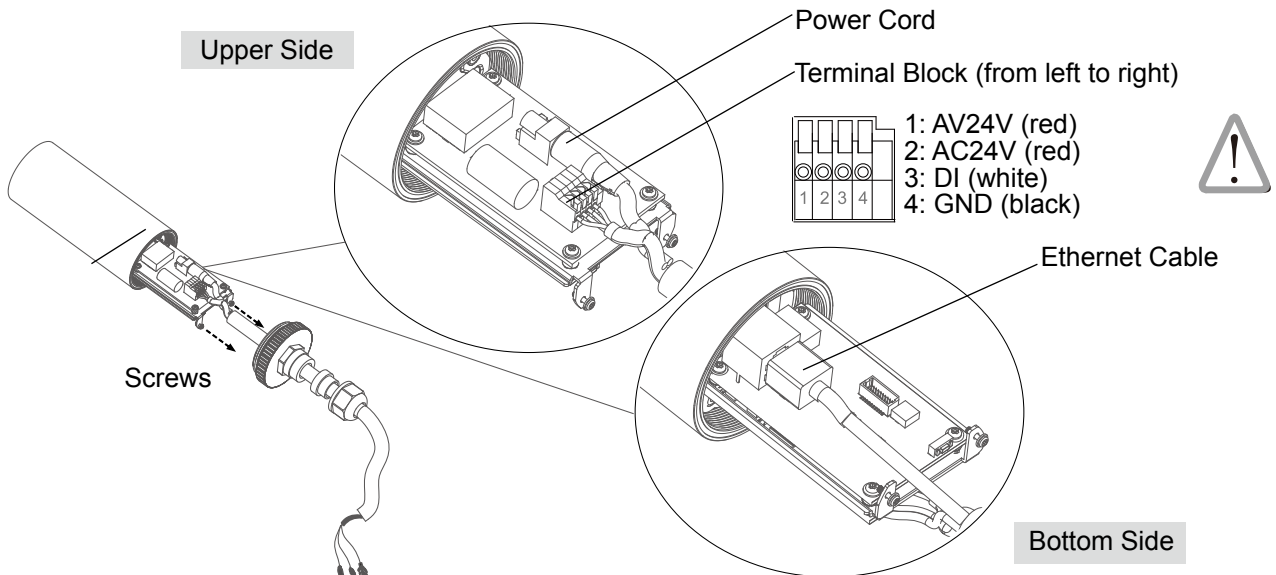

## Network Deployment

### Setup the Network Camera over the Internet

This section explains how to configure the Network Camera to Internet connection.

1. If you have external devices such as sensors and alarms, make the connection from the general I/O terminal block.
2. Use the supplied RJ45 female/female coupler to connect the Network Camera to a switch.
3. Connect the power cable from the Network Camera to a power outlet.

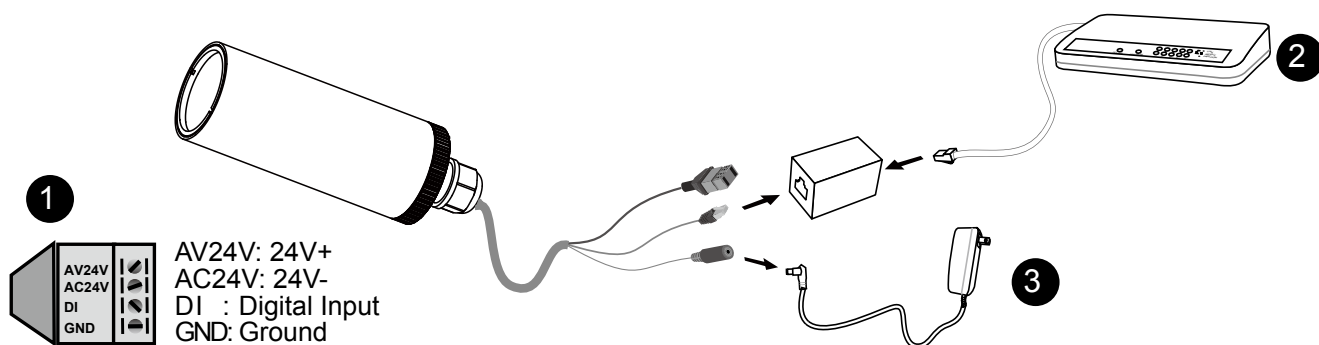

There are several ways to set up the Network Camera over the Internet. The first way is to set up the Network Camera behind a router. The second way is to utilize a static IP. The third way is to use PPPoE.

### Internet connection via a router

Before setting up the Network Camera over the Internet, make sure you have a router and follow the steps below.

1. Connect your Network Camera behind a router, the Internet environment is illustrated below. Regarding how to obtain your IP address, please refer to Software installation on page 10 for details.

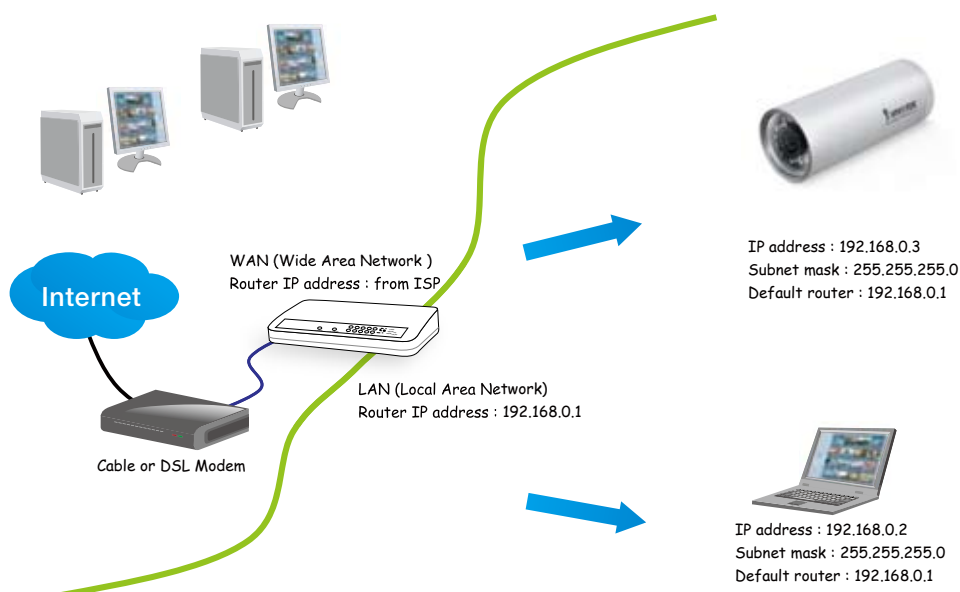

2. In this case, if the Local Area Network (LAN) IP address of your Network Camera is 192.168.0.3, please forward the following ports for the Network Camera on the router.

- HTTP port
- RTSP port
- RTP port for audio
- RTCP port for audio
- RTP port for video
- RTCP port for video

If you have changed the port numbers on the Network page, please open the ports accordingly on your router. For information on how to forward ports on the router, please refer to your router's user's manual.

3. Find out the public IP address of your router provided by your ISP (Internet Service Provider). Use the public IP and the secondary HTTP port to access the Network Camera from the Internet. Please refer to Network Type on page 30 for details.

### **Internet connection with static IP**

Choose this connection type if you are required to use a static IP for the Network Camera. Please refer to LAN on page 30 for details.

### **Internet connection via PPPoE (Point-to-Point over Ethernet)**

Choose this connection type if you are connected to the Internet via a DSL Line. Please refer to PPPoE on page 31 for details.

## **Set up the Network Camera through Power over Ethernet (PoE)**

### **When using a PoE-enabled switch**

The Network Camera is PoE-compliant, which allows it to be powered via a single Ethernet cable. If your switch/router supports PoE, refer to the following illustration to connect the Network Camera to a PoE-enabled switch/router.

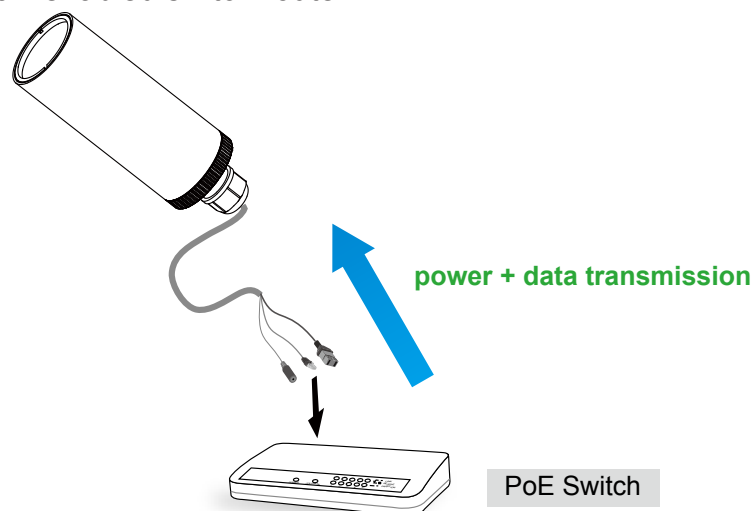



### **When using a non-PoE switch**

If your switch/router does not support PoE, use a PoE power injector (optional) to connect the Network Camera and a non-PoE switch/router.

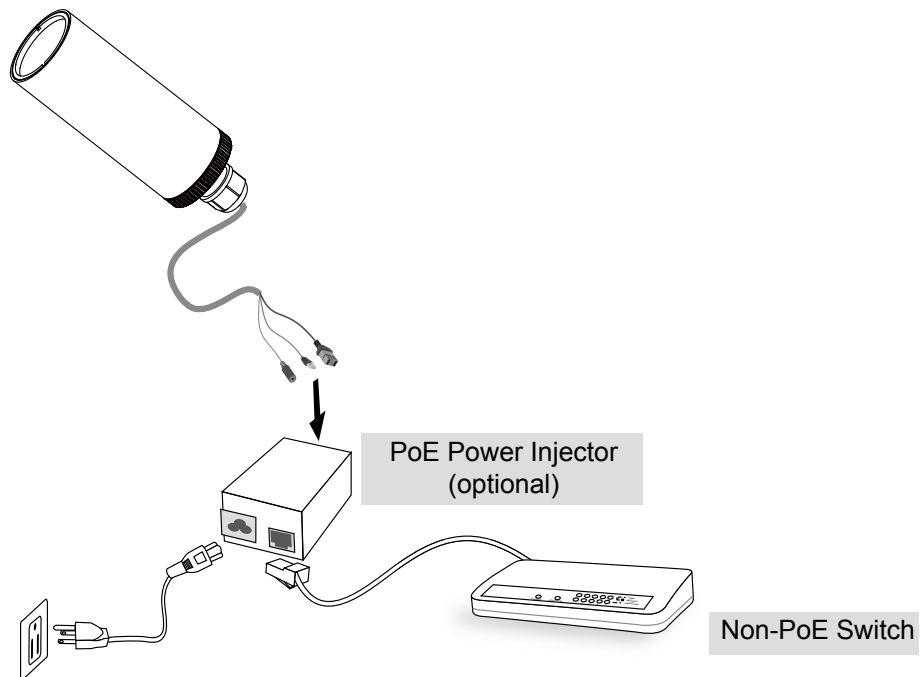

## Software Installation

Installation Wizard 2 (IW2), free-bundled software included on the product CD, helps you set up your Network Camera on the LAN.

1. Install IW2 from the Software Utility directory on the software CD.  
Double click the IW2 shortcut on your desktop to launch the program.



2. The program will conduct an analysis of your network environment.  
After your network environment is analyzed, please click **Next** to continue the program.



3. The program will search for all VIVOTEK network devices on the same LAN.
4. After searching, the main installer window will pop up. Click on the MAC and model name which matches the product label on your device to connect to the Network Camera via Internet Explorer.

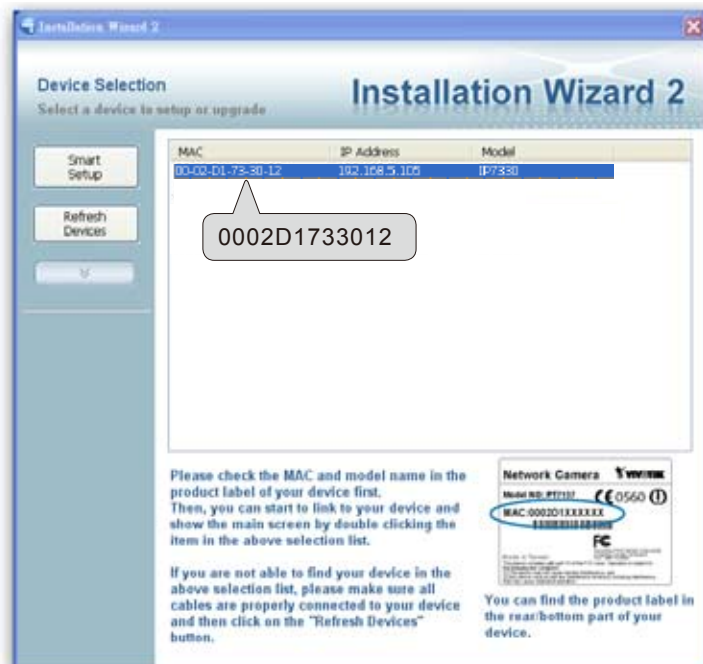

# Accessing the Network Camera

This chapter explains how to access the Network Camera through web browsers, RTSP players, 3GPP-compatible mobile devices, and VIVOTEK recording software.

## Using Web Browsers

Use Installation Wizard 2 (IW2) to access to the Network Cameras installed on the LAN.

If your network environment is not a LAN, follow these steps to access the Network Camera:

1. Launch your web browser (ex. Microsoft® Internet Explorer, Mozilla Firefox, or Netscape).
2. Enter the IP address of the Network Camera in the address field. Press **Enter**.
3. The live video will be displayed in your web browser.
4. If this is the first time installing the VIVOTEK network camera, an information bar will pop up as shown below. Follow the instructions to install the required plug-in on your computer.

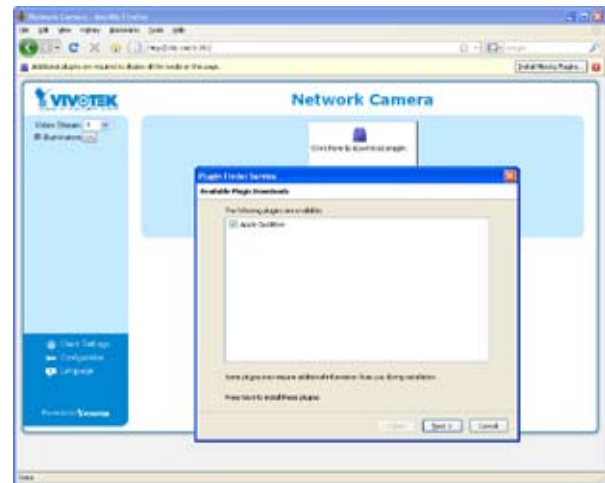
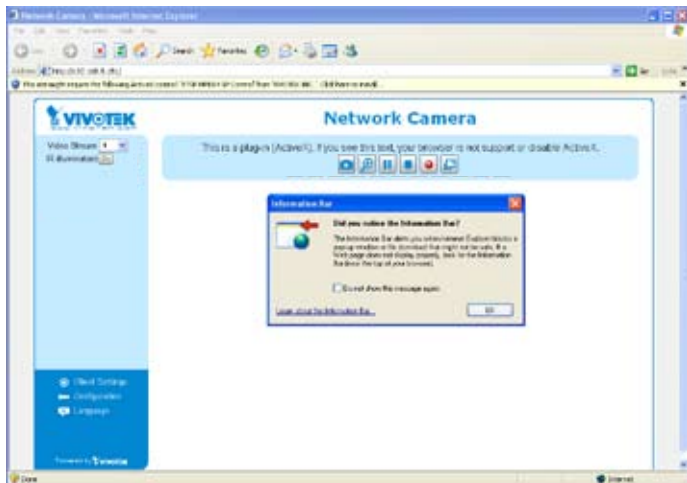

### **NOTE**

- For Mozilla Firefox or Netscape users, your browser will use Quick Time to stream the live video. If you don't have Quick Time on your computer, please install it first, then launch the web browser.

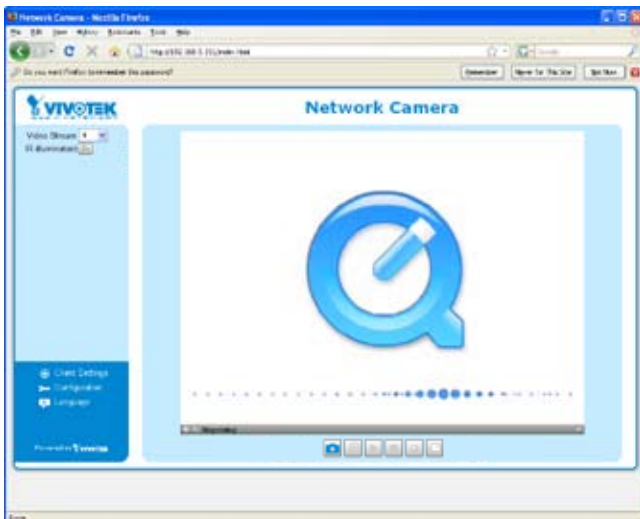

- ▶ *By default, the Network Camera is not password-protected. To prevent unauthorized access, it is highly recommended to set a password for the Network Camera. For more information about how to enable password protection, please refer to Security on page 24.*
- ▶ *If you see a dialog box indicating that your security settings prohibit running ActiveX® Controls, please enable the ActiveX® Controls for your browser.*

1. Choose **Tools > Internet Options > Security > Custom Level**.

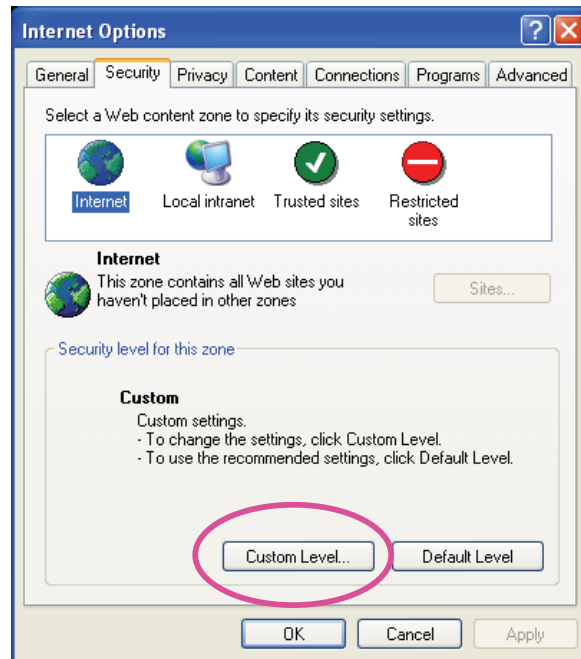

2. Look for **Download signed ActiveX® controls**; select **Enable** or **Prompt**. Click **OK**.

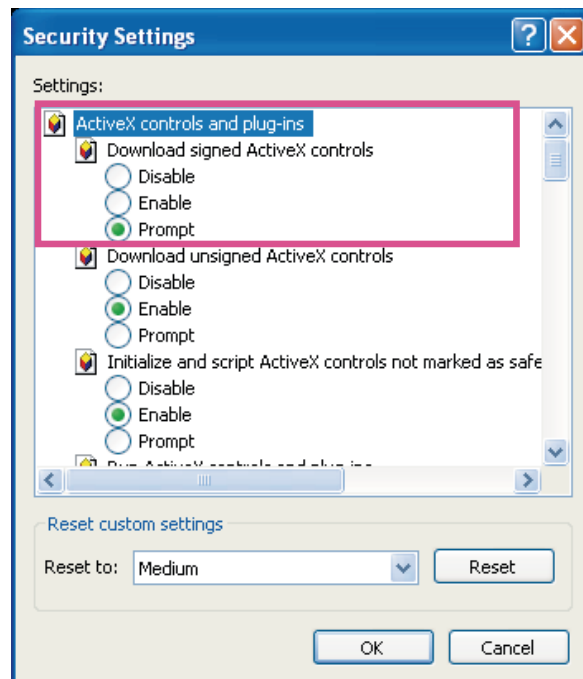

3. Refresh your web browser, then install the Active X® control. Follow the instructions to complete installation.

## Using RTSP Players

To view the MPEG-4 streaming media using RTSP players, you can use one of the following applications that support RTSP streaming.



Quick Time Player



Real Player

1. Launch a RTSP player.
2. Choose File > Open URL. A URL dialog box will pop up.
3. The format is `rtsp://<ip address>:<rtsp port>/<RTSP streaming access name for stream1 or stream2>`

As most ISPs and players only allow RTSP streaming through port number 554, please set the RTSP port to 554. For more information, please refer to RTSP Streaming on page 36.

For example:

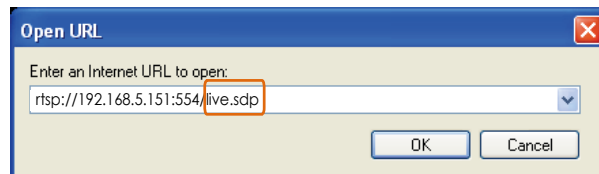

4. The live video will be displayed in your player.  
For more information on how to configure the RTSP access name, please refer to RTSP Streaming on page 36 for details.



## Using 3GPP-compatible Mobile Devices

To view the streaming media through 3GPP-compatible mobile devices, make sure the Network Camera can be accessed over the Internet. For more information on how to set up the Network Camera over the Internet, please refer to Setup the Network Camera over the Internet on page 7.

To utilize this feature, please check the following settings on your Network Camera:

1. Because most players on 3GPP mobile phones do not support RTSP authentication, make sure the authentication mode of RTSP streaming is set to disable.  
For more information, please refer to RTSP Streaming on page 36.
2. As the the bandwidth on 3G networks is limited, larger video sizes are not available. Please set the video and audio streaming parameters as listed below.  
For more information, please refer to Video on page 43.

Video Mode	MPEG-4
Frame size	176 x 144
Maximum frame rate	5 fps
Intra frame period	1S
Video quality (Constant bit rate)	40kbps
Audio type (GSM-AMR)	12.2kbps

3. As most ISPs and players only allow RTSP streaming through port number 554, please set the RTSP port to 554. For more information, please refer to RTSP Streaming on page 36.
4. Launch the player on the 3GPP-compatible mobile device (ex. Real Player).
5. Type the following URL command into the player.  
The address format is `rtsp://<public ip address of your camera>:<rtsp port>/<RTSP streaming access name for stream1 or stream2>`.  
For example:

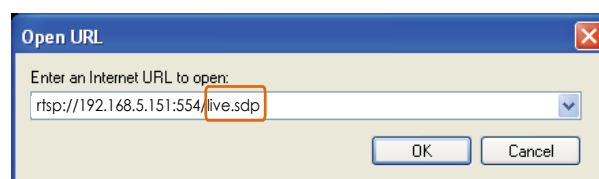

## Using VIVOTEK Recording Software

The product software CD also contains VIVOTEK's recording software, allowing simultaneous monitoring and video recording for multiple Network Cameras. Please install the recording software, then launch the program to add the Network Camera to the Channel list. For detailed information about how to use the recording software, please refer to the user's manual of the software or download the manual from <http://www.vivotek.com>.



# Main Page

This chapter explains the layout of the main page. It is composed of the following sections: VIVOTEK INC. Logo, Host Name, Camera Control Area, Configuration Area, Menu, and Live Video Window.

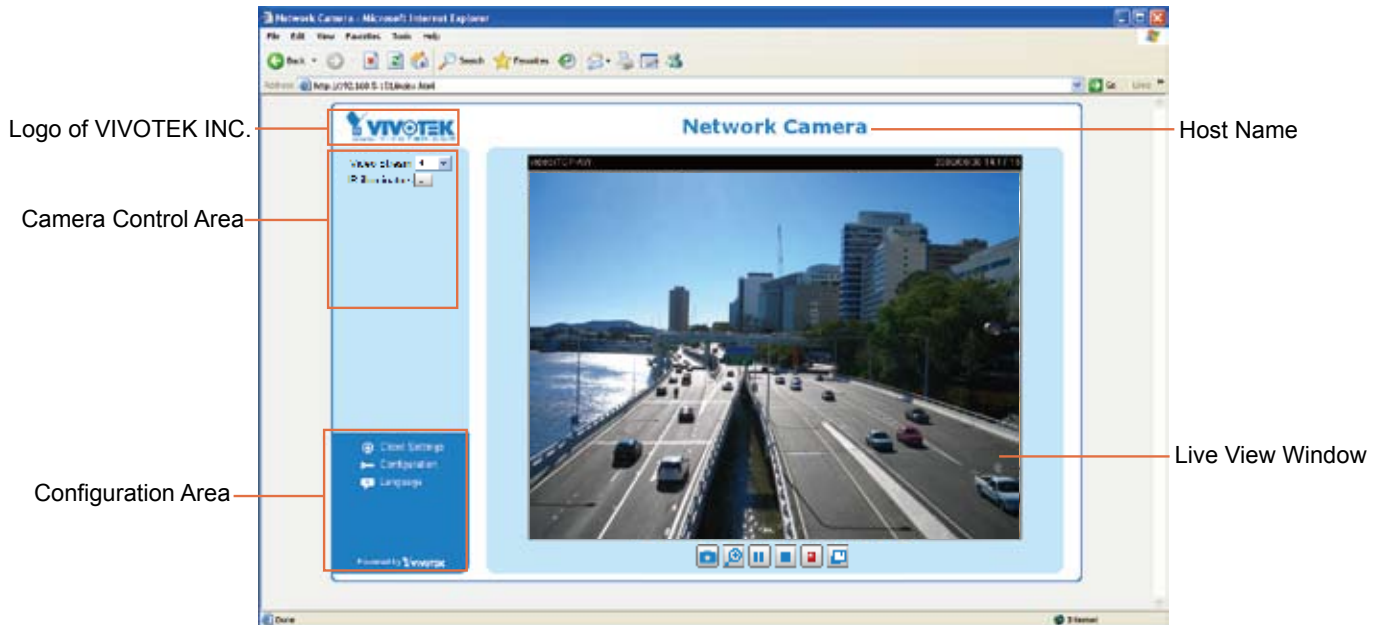

## VIVOTEK INC. Logo

Click this logo to visit the VIVOTEK website.

## Host Name

The host name can be customized to fit your needs. For more information, please refer to System on page 22.

## Camera Control Area

**Video Stream:** This Network Camera supports MJPEG or MPEG-4 dual streams simultaneously. You can select either one for live viewing.

**IR Illuminators:** Click to turn on the IR LEDs for 20 seconds.

## Configuration Area

**Client Settings:** Click this button to access the client setting page. For more information, please refer to Client Settings on page 19.

**Configuration:** Click this button to access the configuration page of the Network Camera. It is suggested that a password be applied to the Network Camera so that only the administrator can configure the Network Camera. For more information, please refer to Configuration on page 21.

**Language:** Click this button to choose a language for the user interface. Language options are available in: English, Deutsch, Español, Français, Italiano, 日本語, Português, 簡體中文, and 繁體中文.



## Live Video Window

■ The following window is displayed when the video mode is set to MPEG-4:

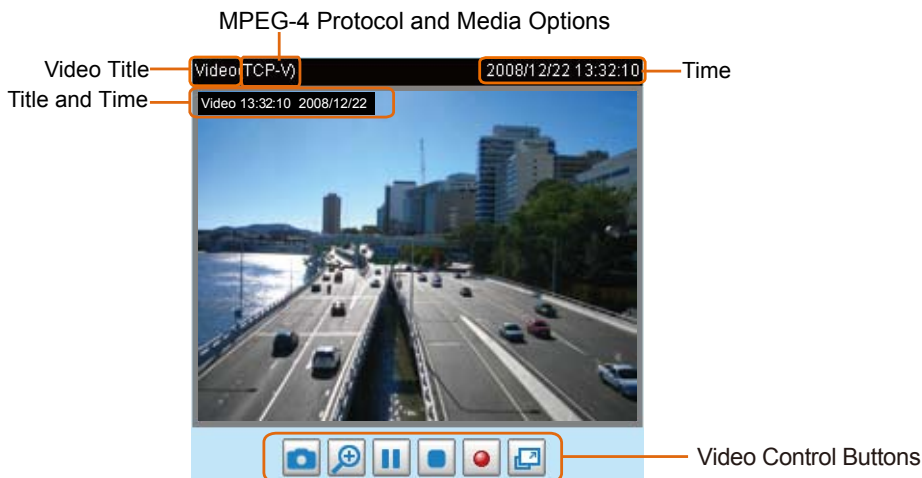

**Video Title:** The video title can be configured. For more information, please refer to Video settings on page 43.

**MPEG-4 Protocol and Media Options:** The transmission protocol and media options for MPEG-4 video streaming. For further configuration, please refer to Client Settings on page 19.

**Time:** Display the current time. For further configuration, please refer to Video settings on page 43.



**Title and Time:** The video title and time can be stamped on the streaming video. For further configuration, please refer to Video settings on page 43.



**Video Control Buttons:** Depending on the Network Camera model and Network Camera configuration, some buttons may not be available.

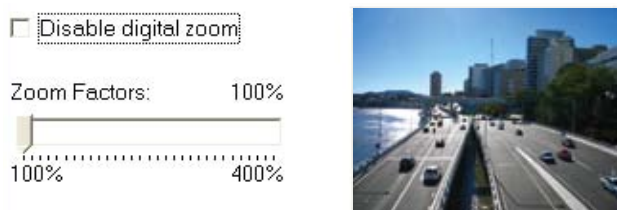

 **Snapshot:** Click this button to capture and save still images. The captured images will be displayed in a pop-up window. Right-click the image and choose **Save Picture As** to save it in JPEG (\*.jpg) or BMP (\*.bmp) format.

 **Digital Zoom:** Click and uncheck “Disable digital zoom” to enable the zoom operation. The navigation screen indicates the part of the image being magnified. To control the zoom level, drag the slider bar. To move to a different area you want to magnify, drag the navigation screen image.



 **Pause:** Pause the transmission of the streaming media. The button becomes the  Resume button after clicking the Pause button.

 **Stop:** Stop the transmission of streaming media. Click the  Resume button to continue transmission.

 **Start MP4 Recording:** Click this button to record video clips in MP4 file format. Press the  Stop MP4 Recording button to end recording. When you exit the web browser, video recording stops accordingly. To specify the storage destination and the file name, please refer to MP4 Saving Options on page 20 for details.

 **Full Screen:** Click this button to switch to full screen mode. Press the “Esc” key to switch back to normal mode.

■ The following window is displayed when the video mode is set to MJPEG:





**Video Title:** The video title can be configured. For more information, please refer to Video Settings on page 43.

**Time:** Display the current time. For more information, please refer to Video Settings on page 43.



**Title and Time:** The video title and time can be stamped on the streaming video. For more information, please refer to Video Settings on page 43.

**Video Control Buttons:** Depending on the Network Camera model and Network Camera configuration, some buttons may not be available.

 **Snapshot:** Click this button to capture and save still images. The captured images will be displayed in a pop-up window. Right-click the image and choose **Save Picture As** to save it in JPEG (\*.jpg) or BMP (\*.bmp) format.

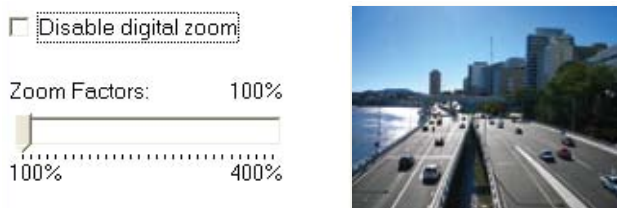
 **Digital Zoom:** Click and uncheck “Disable digital zoom” to enable the zoom operation. The navigation screen indicates the part of the image being magnified. To control the zoom level, drag the slider bar. To move to a different area you want to magnify, drag the navigation screen image.



 **Start MP4 Recording:** Click this button to record video clips in MP4 file format. Press the  Stop MP4 recording button to end recording. When you exit the web browser, video recording stops accordingly. To specify the storage destination and file name, please refer to MP4 Saving Options on page 20 for details.

 **Full Screen:** Click this button to switch to full screen mode. Press the “Esc” key to switch back to normal mode.

# Client Settings

This chapter explains how to select the stream transmission mode and saving options on the local computer. When finished with the settings on this page, click **Save** on the bottom of the page to enable the settings.

## MPEG-4 Protocol Options

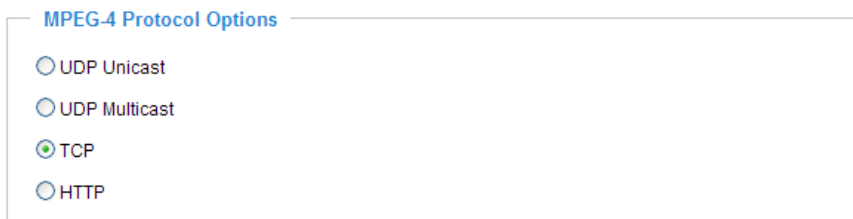

MPEG-4 Protocol Options

- UDP Unicast
- UDP Multicast
- TCP
- HTTP

Depending on your network environment, there are four transmission modes for MPEG-4 streaming:

UDP unicast: This protocol allows for better real-time audio and video streams. However, network packets may be lost due to network burst traffic and images may be broken. Activate the UDP connection when occasions require time-sensitive responses and the video quality is less important. Note that each unicast client connecting to the server takes up additional bandwidth and the Network Camera allows up to ten simultaneous accesses.

UDP multicast: This protocol allows multicast-enabled routers to forward network packets to all clients requesting streaming media. This helps to reduce the network transmission load of the Network Camera while serving multiple clients at the same time. Note that to utilize this feature, the Network Camera must be configured to enable multicast streaming at the same time. For more information, please refer to RTSP Streaming on page 36.

TCP: This protocol guarantees the complete delivery of streaming data and thus provides better video quality. However, the real-time effect is not as good as that of the UDP protocol.

HTTP: This protocol allows for the same transmission quality as the TCP protocol without needing to open specific ports for streaming under some network environments. Users inside a firewall can utilize this protocol to allow streaming data through.

## MP4 Saving Options

**MP4 Saving Options**

Folder:

File name prefix:

Add date and time suffix to file name

Users can record live video as they are watching by clicking  Start MP4 Recording on the main page. Here, you can specify the storage destination and file name.

**Folder:** Specify the storage destination for the recorded video files.

**File name prefix:** Enter the text that will be appended to the front of the video file name.

**Add date and time suffix to the file name:** Select this option to append the date and time to the end of the file name.

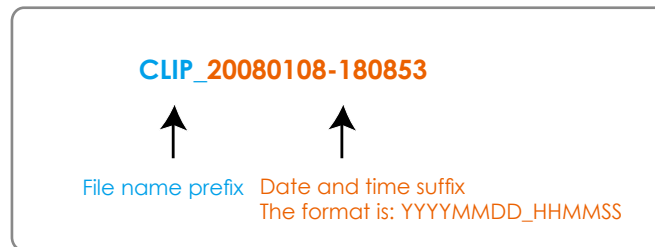

# Configuration

Click **Configuration** on the main page to enter the camera setting pages. Note that only Administrators can access the configuration page.

VIVOTEK offers an easy-to-use user interface that helps you set up your network camera with minimal effort. To simplify the setting procedure, two types of user interfaces are available: Advanced Mode for professional users and Basic Mode for entry-level users. Some advanced functions (HTTPS/ Access list/ Homepage layout/ Application/ Recording/ System log/ View parameters) are not displayed in Basic Mode.

If you want to set up advanced functions, please click **[Advanced Mode]** on the bottom of the configuration list to quickly switch to Advanced Mode.

In order to simplify the user interface, the detailed information will be hidden unless you click on the function item. When you click on the first sub-item, the detailed information for the first sub-item will be displayed; when you click on the second sub-item, the detailed information for the second sub-item will be displayed and that of the first sub-item will be hidden.

The following is the interface of the Basic Mode and the Advanced Mode:

## Basic Mode

The screenshot displays the VIVOTEK configuration web interface. On the left is a blue sidebar menu with the following items: Home, System (highlighted), Security, Network, DDNS, Video, Motion detection, Camera tampering detection, and Maintenance. Below the menu is a button labeled "[ Advanced mode ]". At the bottom left of the sidebar, it shows "Version: 0100a". The main content area is titled ">System" and contains three configuration sections:
 

- System**: Host name: Network Camera
- System Time**: Radio buttons for "Keep current date and time" (selected), "Synchronize with computer time", "Manual", and "Automatic".
- DI**: Digital input: The active state is Low; the current state detected is Low. A "Save" button is located below this section.

 Annotations with orange lines point to:
 

- "Configuration list" pointing to the sidebar menu.
- "Click to switch to Advanced mode" pointing to the "[ Advanced mode ]" button.
- "Firmware Version" pointing to "Version: 0100a".

## Advanced Mode

Each function on the configuration list will be explained in the following sections. Those functions that are displayed only in Advanced Mode are marked with **Advanced Mode**. If you want to set up the advanced functions, please click **[Advanced Mode]** on the bottom of the configuration list to quickly switch over.

## System

This section explains how to configure the basic settings for the Network Camera, including host name and system time. It is composed of the following three columns: System, System Time and DI. When completed with the settings on this page, click **Save** at the bottom of the page to enable the settings.

### System

**System**

Host name:

**Host name:** Enter a desired name for the Network Camera. The text will be displayed at the top of the main page.

## System Time

**System Time**

Time zone:

Note: You can upload your Daylight Saving Time rules on [Maintenance](#) page or use the camera default value.

Keep current date and time

Sync with computer time:

Manual:

Automatic:

**Keep current date and time:** Select this option to preserve the current date and time of the Network Camera. The Network Camera's internal real-time clock maintains the date and time even when the system power is turned off.

**Sync with computer time:** Select this option to synchronize the date and time of the Network Camera with the local computer. The read-only date and time of the PC is displayed when updated.

**Manual:** The administrator can enter the date and time manually. Note that the date and time format is [yyyy/mm/dd] and [hh:mm:ss].

**Automatic:** The Network Time Protocol is a protocol which synchronizes computer clocks by periodically querying an NTP Server.

**NTP server:** Assign the IP address or domain name of the time-server. Leaving the text box blank connects the Network Camera to the default time servers.

**Update interval:** Select to update the time using the NTP server on an hourly, daily, weekly, or monthly basis.

**Time zone Advanced Mode:** Select the appropriate time zone from the list. If you want to upload Daylight Savings Time rules on the Maintenance page, please refer to Upload / Export Daylight Saving Time Configuration File on page 75 for details.

## DI

**DI**

Digital input: The active state is ; the current state detected is Low

**Digital input:** Select **High** or **Low** to define the normal status for the digital input. The Network Camera will report the current status.

## Security

This section explains how to enable password protection and create multiple accounts.

### Root Password

The administrator you want to add more accounts in the Manage User column, please set a password for the “root” account first.

1. Type the password in both text boxes, then click **Save** to enable password protection.
2. A window will be prompted for authentication; type the correct user’s name and password in their respective fields to access the Network Camera.

### Manage Privilege Advanced mode

Allow anonymous viewing: If you check this item, any client can access the live stream without entering a User ID and Password.

### Manage User

Administrators can add up to 20 user accounts.

1. Input the new user’s name and password.
2. Select the privilege level for the new user account. Click **Add** to enable the setting.

Access rights are sorted by user privilege (Administrator, Operator, and Viewer). Only administrators can access the Configuration page. Operators cannot access the Configuration page but can use the URL Commands to get and set the value of parameters. For more information, please refer to URL Commands of the Network Camera on page 78. Viewers access only the main page for live viewing.

Here you also can change a user’s access rights or delete user accounts.

1. Select an existing account to modify.
2. Make necessary changes and click **Update** or **Delete** to enable the setting.



## HTTPS (Hypertext Transfer Protocol over SSL) Advanced Mode

This section explains how to enable authentication and encrypted communication over SSL (Secure Socket Layer). It helps protect streaming data transmission over the Internet on higher security level.

### Enable HTTPS

Check this item to enable HTTPS communication, then select a connection option: "HTTP & HTTPS" or "HTTPS only". Note that you have to create and install a certificate first in the second column before clicking the **Save** button.

**Enable HTTPS**

\*To enable HTTPS, you have to create and install certificate first.

Enable HTTPS secure connection:

HTTP & HTTPS  HTTPS only

**Save**

**Create and install certificate method**

Create self-signed certificate automatically

Create self-signed certificate manually:

Create certificate request and install:

### Create and Install Certificate Method

Before using HTTPS for communication with the Network Camera, a **Certificate** must be created first. There are three ways to create and install a certificate:

#### Create self-signed certificate automatically

1. Select this option.
2. In the first column, check **Enable HTTPS secure connection**, then select a connection option: "HTTP & HTTPS" or "HTTPS only".
3. Click **Save** to generate a certificate.

**Enable HTTPS**

\*To enable HTTPS, you have to create and install certificate first.

Enable HTTPS secure connection:

HTTP & HTTPS  HTTPS only

**Save**

**Create and install certificate method**

Create self-signed certificate automatically

Create self-signed certificate manually:

Create certificate request and install:

Please wait while the certificate is being generated...

**Certificate Information**

Status: Not installed

4. The Certificate Information will automatically be displayed in the third column as shown below. You can click **Property** to view detailed information about the certificate.

**Certificate Information**

Status:	Active
Country:	TW
State or province:	Asia
Locality:	Asia
Organization:	Vivotek.Inc
Organization Unit:	Vivotek.Inc
Common Name:	www.vivotek.com

5. Click **Home** to return to the main page. Change the address from “http://” to “https://” in the address bar and press **Enter** on your keyboard. Some Security Alert dialogs will pop up. Click **OK** or **Yes** to enable HTTPS.

https://

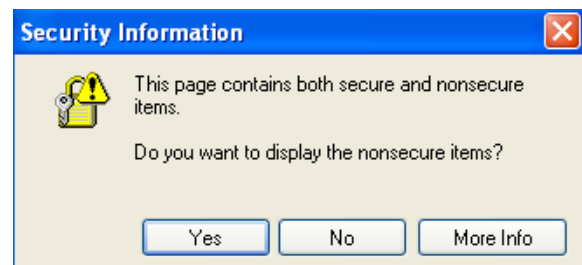
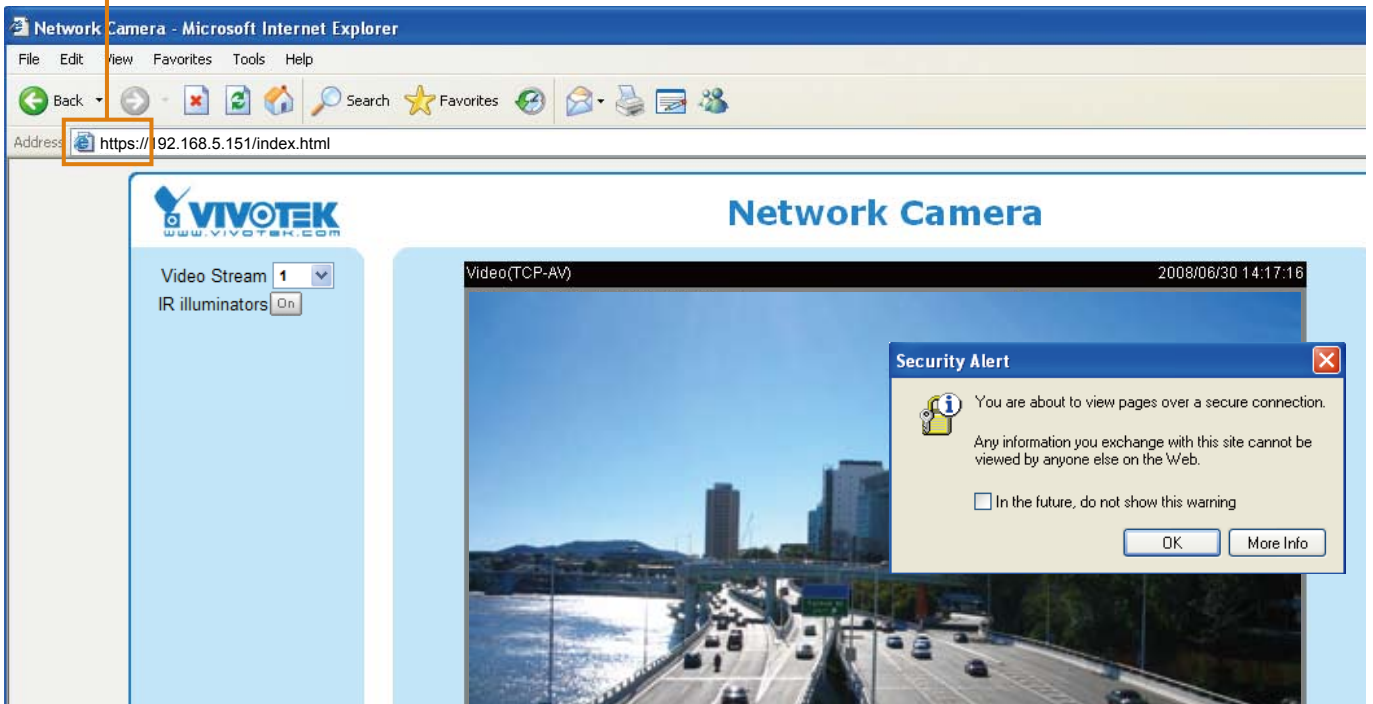

**Create self-signed certificate manually**

1. Select this option.
2. Click **Create** to open a Create Certificate page, then click **Save** to generate the certificate.

**Create and install certificate method**

Create self-signed certificate automatically  
 Create self-signed certificate manually:  
 Self-signed certificate:   
 Create certificate request and install:

---

**Create Certificate**

Country:   
 State or province:   
 Locality:   
 Organization:   
 Organization Unit:   
 Common Name:   
 Validity:  days

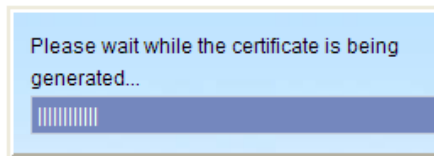

3. The Certificate Information will automatically be displayed in the third column as shown below. You can click **Property** to see detailed information about the certificate.

**Certificate Information**

Status:   
 Country: TW  
 State or province: Asia  
 Locality: Asia  
 Organization: Vivotek.Inc  
 Organization Unit: Vivotek.Inc  
 Common Name: www.vivotek.com

**Create certificate and install** : Select this option if you want to create an official certificate issued by a CA (Certificate Authority).

1. Select this option.
2. Click **Create** to open the Create Certificate page, then click **Save** to generate the certificate.

**Create and install certificate method**

Create self-signed certificate automatically  
 Create self-signed certificate manually:  
 Create certificate request and install:  
 Certificate request:   
 Select certificate file:

**Create Certificate**

Country:

State or province:

Locality:

Organization:

Organization Unit:

Common Name:

Validity:  days

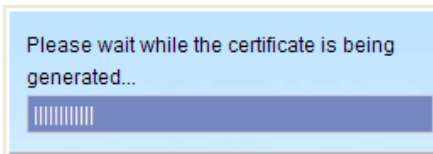

3. If you see the following Information bar, click **OK** and click on the Information bar on the top of the page to allow pop-ups.

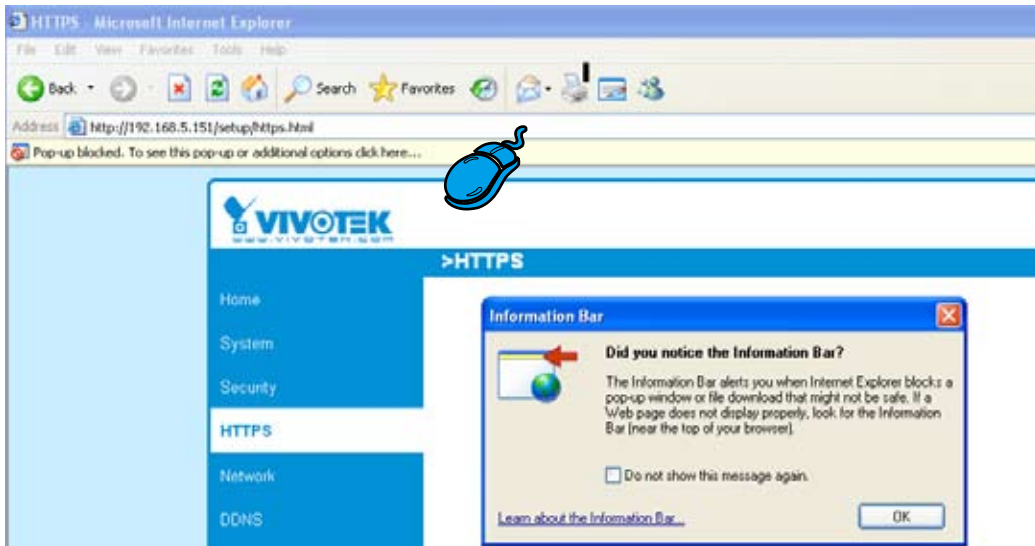

4. The pop-up window shows an example of a certificate request.

**Create Certificate Request Completed**

Copy the PEM format request below and send it to a CA for identify validation. After that, you have to install it by clicking the "Upload" button on HTTPS page.

**Certificate Request (PEM format)**

```

-----BEGIN CERTIFICATE REQUEST-----
MIIBuDCCASECADB5MQswCQYDVQQGEwJUVzZERMAsGA1UECBMIUHJvdmluY2UxLjEjAQ
BgNVBACTCUNpdHkgTmFtZTEaMBGGA1UEChMRMTJyY2UxLjEjAQBgNVBAsTCVUuaXQg
TmFtZTEaMBGGA1UEAxMKSVAgQWRkcmVzcCBnzANBgkqhkiG9w0BAQEFAAOBjQAwgYkCg
YEAuOT75EY52gsSyPFMxZ7wHdQ1obPescsXLUx9DFw6OMRheukFaXFDkM+5xk+K5oEPBPqj
77yhH+zdUHS27fFSLG57bW9SoxrWuLhSvRZwmCD+//AiJX864dJ/mjHn7Wc55GFaxgMvb
ALcxT+hCIeDCWYnRqh/fpKNj+BxvVoN UrcAweAAaAAAMAOGCSqGSIb3DQEBBQUAA4GBAAVaz
WOAtftfU9dyFgTxOY01D/zOF0TkbndOQG18e4ftJ3rROD1TvIIMjg3K8zsAS8Gd3pME1ejqL
YoBrtaSqdCUqGiX50bLG1subWsxr88PngaBwjYoTpG3q1zvUPJZLAVmdL3ne5urTbABXOSc
CHOQGtH+PX9dw4OJWkIC8QhV
-----END CERTIFICATE REQUEST-----

```

5. Look for a trusted certificate authority that issues digital certificates. Enroll the Network Camera. Wait for the certificate authority to issue a SSL certificate; click Browse... to search for the issued certificate, then click **Upload** in the second column.

**Create and install certificate method**

Create self-signed certificate automatically  
 Create self-signed certificate manually:  
 Create certificate request and install:

Certificate request:   
 Select certificate file:

---

**Certificate Information**

Status:

**NOTE**

► How do I cancel the HTTPS settings?

1. Uncheck **Enable HTTPS secure connection** in the first column and click **Save**; a warning dialog will pop up.
2. Click **OK** to disable HTTPS.

**Enable HTTPS**

\*To enable HTTPS, you have to create and install certificate first.

Enable HTTPS secure connection:

**Create and install certificate method**

Create self-signed certificate automatically

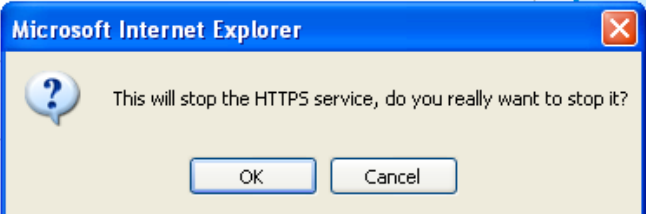

3. The webpage will redirect to a non-HTTPS page automatically.

► If you want to create and install other certificates, please remove the existing one. To remove the signed certificate, uncheck **Enable HTTPS secure connection** in the first column and click **Save**. Then click **Remove** to erase the certificate.

**Certificate Information**

Status:

Country:  
 State or province:  
 Locality:  
 Organization:  
 Organization Unit:  
 Common Name:

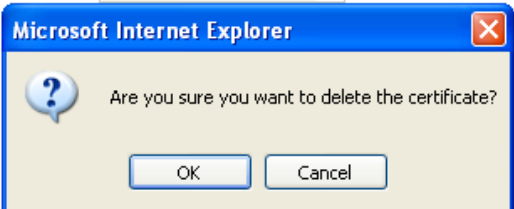

## Network

This section explains how to configure a wired network connection for the Network Camera.

### Network Type

**Network Type**

LAN:

- Get IP address automatically
- Use fixed IP address:
- Enable UPnP presentation
- Enable UPnP port forwarding

PPPoE:

### LAN

Select this option when the Network Camera is deployed on a local area network (LAN) and is intended to be accessed by local computers. The default setting for the Network Type is LAN. Remember to click **Save** when you complete the Network setting.

Get IP address automatically: Select this option to obtain an available dynamic IP address assigned by the DHCP server each time the camera is connected to the LAN.

Use fixed IP address: Select this option to manually assign a static IP address to the Network Camera.

**Network Type**

LAN:

- Get IP address automatically
- Use fixed IP address:

IP address:

Subnet mask:

Default router:

Primary DNS:

Secondary DNS:

Primary WINS server:

Secondary WINS server:

- Enable UPnP presentation
- Enable UPnP port forwarding

PPPoE:

1. You can make use of VIVOTEK Installation Wizard 2 on the software CD to easily set up the Network Camera on LAN. Please refer to Software installation on page 10 for details.
2. Enter the static IP, Subnet mask, Default router, and Primary DNS provided by your ISP.

Enable UPnP presentation: Select this option to enable UPnP™ presentation for your Network Camera so that whenever a Network Camera is presented to the LAN, shortcuts of connected Network Cameras will be listed in My Network Places. You can click the shortcut to link to the web browser. Currently, UPnP™ is supported by Windows XP or later. Note that to utilize this feature, please make sure the UPnP™ component is installed on your computer.

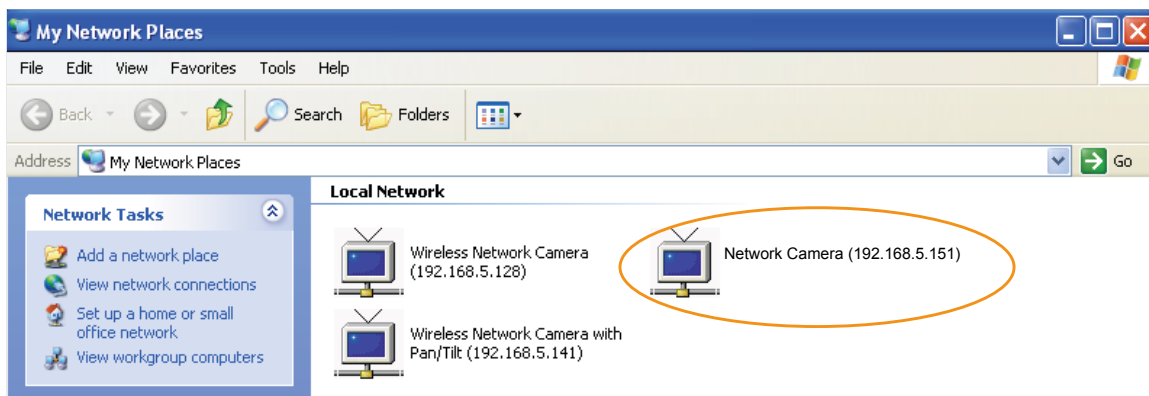

**Enable UPnP port forwarding:** To access the Network Camera from the Internet, select this option to allow the Network Camera to open ports on the router automatically so that video streams can be sent out from a LAN. To utilize of this feature, make sure that your router supports UPnP™ and it is activated.

### PPPoE (Point-to-point over Ethernet)

Select this option to configure your Network Camera to make it accessible from anywhere as long as there is an Internet connection. Note that to utilize this feature, it requires an account provided by your ISP.

Follow the steps below to acquire your Network Camera's public IP address.

1. Set up the Network Camera on the LAN.
2. Go to Home > Configuration > Application > Server Settings (please refer to Server Settings on page 62) to add a new email or FTP server.
3. Go to Configuration > Application > Media Settings (please refer to Media Settings on page 65). Select System log so that you will receive the system log in TXT file format which contains the Network Camera's public IP address in your email or on the FTP server.
4. Go to Configuration > Network > Network Type. Select PPPoE and enter the user name and password provided by your ISP. Click **Save** to enable the setting.

**Network Type**

LAN:

PPPoE:

User name:

Password:

Confirm password:

5. The Network Camera will reboot.
6. Disconnect the power to the Network Camera; remove it from the LAN environment.

### **NOTE**

- ▶ If the default ports are already used by other devices connected to the same router, the Network Camera will select other ports for the Network Camera.
- ▶ If UPnP™ is not supported by your router, you will see the following message:  
**Error: Router does not support UPnP port forwarding.**

- *Steps to enable UPnP™ user interface on your computer:*  
*Note that you must log on to the computer as a system administrator to install the UPnP™ components.*

1. Go to Start, click **Control Panel**, and then click **Add or Remove Programs**.

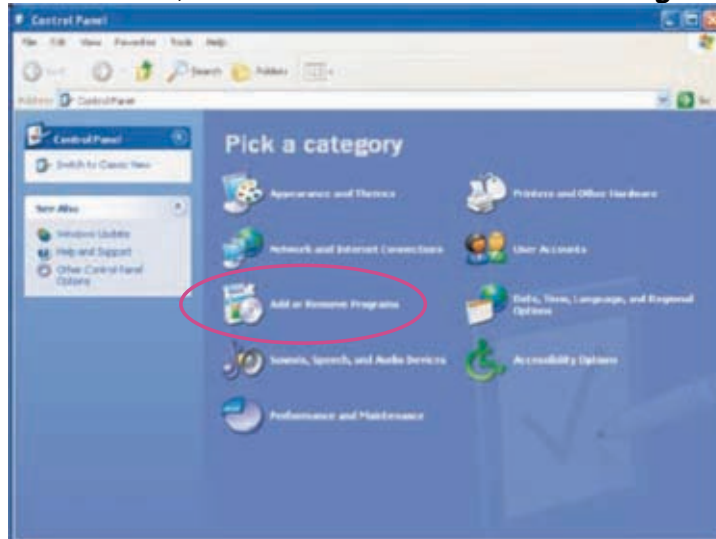

2. In the Add or Remove Programs dialog box, click **Add/Remove Windows Components**.

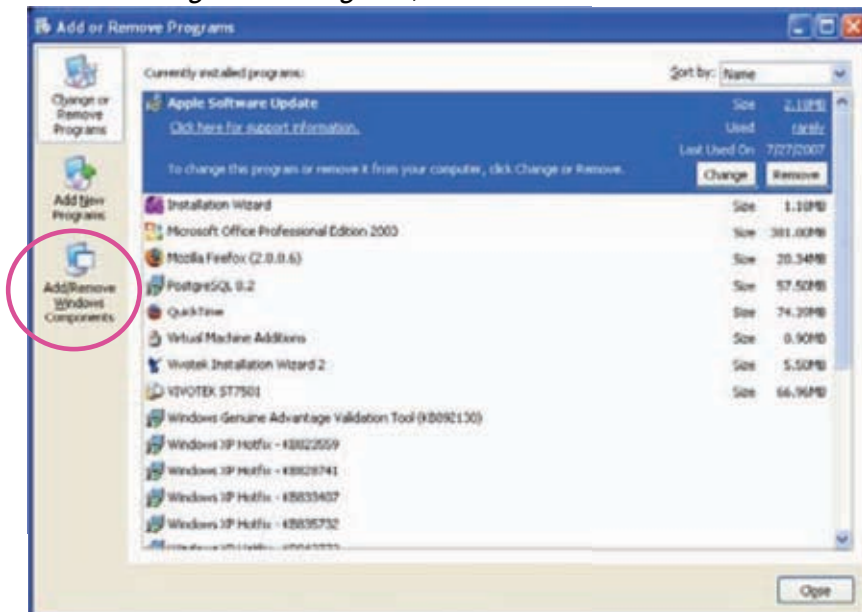

3. In the Windows Components Wizard dialog box, select **Networking Services** and then click **Details**.

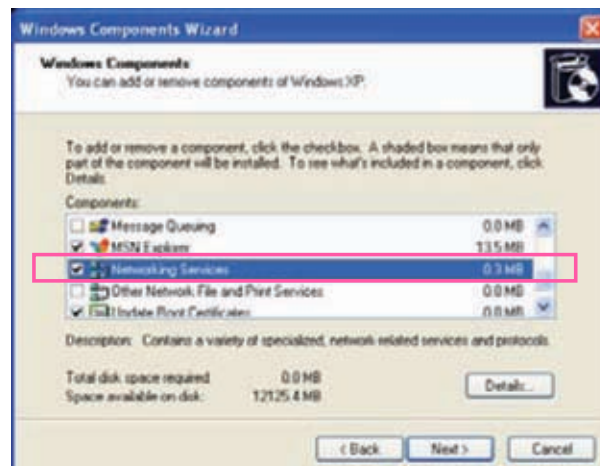



4. In the Networking Services dialog box, select **Universal Plug and Play** and click **OK**.

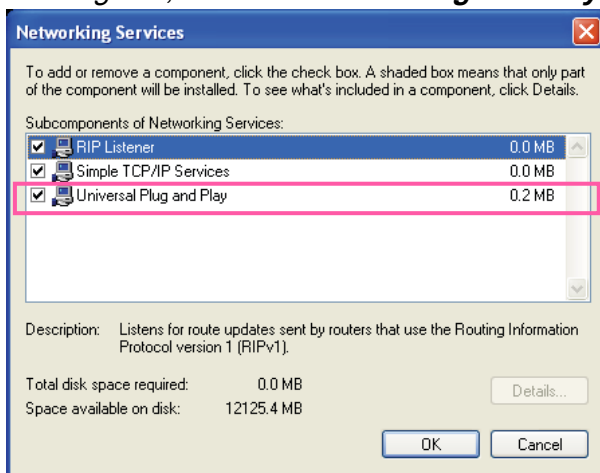

5. Click **Next** in the following window.

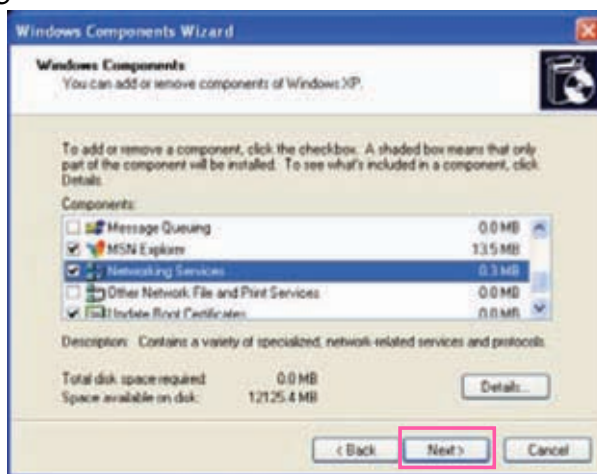

6. Click **Finish**. UPnP™ is enabled.

- ▶ **How does UPnP™ work?**  
 UPnP™ networking technology provides automatic IP configuration and dynamic discovery of devices added to a network. Services and capabilities offered by networked devices, such as printing and file sharing, are available among each other without the need for cumbersome network configuration. In the case of Network Cameras, you will see Network Camera shortcuts under My Network Places.
- ▶ **Enabling UPnP port forwarding allows the Network Camera to open a secondary HTTP port on the router-not HTTP port-meaning that you have to add the secondary HTTP port number to the Network Camera's public address in order to access the Network Camera from the Internet. For example, when the HTTP port is set to 80 and the secondary HTTP port is set to 8080, refer to the list below for the Network Camera's IP address.**

From the Internet	In LAN
http://203.67.124.123:8080	http://192.168.4.160 or http://192.168.4.160:8080

- ▶ **If the PPPoE settings are incorrectly configured or the Internet access is not working, restore the Network Camera to factory default; please refer to Restore on page 74 for details. After the Network Camera is reset to factory default, it will be accessible on the LAN.**

## HTTP **Advanced Mode**

To utilize HTTP authentication, make sure that you have set a password for the Network Camera first; please refer to Security on page 26 for details.

HTTP	
Authentication:	basic
HTTP port:	80
Secondary HTTP port:	8080
Access name for stream 1:	video.mjpg
Access name for stream 2:	video2.mjpg

**Authentication:** Depending on your network security requirements, the Network Camera provides two types of security settings for an HTTP transaction: basic and digest.

If **basic** authentication is selected, the password is sent in plain text format and there can be potential risks of being intercepted. If **digest** authentication is selected, user credentials are encrypted using MD5 algorithm and thus provide better protection against unauthorized accesses.

**HTTP port / Secondary HTTP port:** By default, the HTTP port is set to 80 and the secondary HTTP port is set to 8080. They can also be assigned to another port number between 1025 and 65535. If the ports are incorrectly assigned, the following warning messages will be displayed:

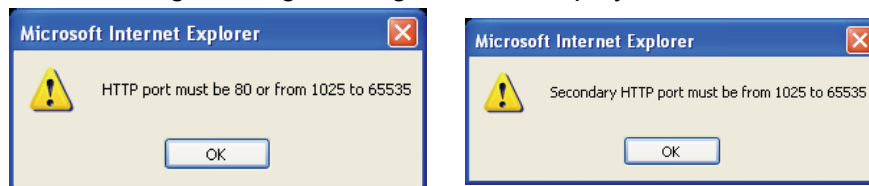

To access the Network Camera on the LAN, both the HTTP port and secondary HTTP port can be used to access the Network Camera. For example, when the HTTP port is set to 80 and the secondary HTTP port is set to 8080, refer to the list below for the Network Camera's IP address.

In LAN
http://192.168.4.160 or
http://192.168.4.160:8080

**Access name for stream 1 / Access name for stream 2:** The access name is used to differentiate the streaming source.

When using Mozilla Firefox or Netscape to access the Network Camera and the video mode is set to JPEG, users will receive video comprised of continuous JPEG images. This technology, known as "server push", allows the Network Camera to feed live pictures to Mozilla Firefox and Netscape.

URL command -- <http://<ip address>:<http port>/<access name for stream1 or stream2>>

For example, when the Access name for stream 2 is set to [video2.mjpg](#):

1. Launch Mozilla Firefox or Netscape.
2. Type the URL command in the address bar. Press **Enter**.
3. The JPEG images will be displayed in your web browser.

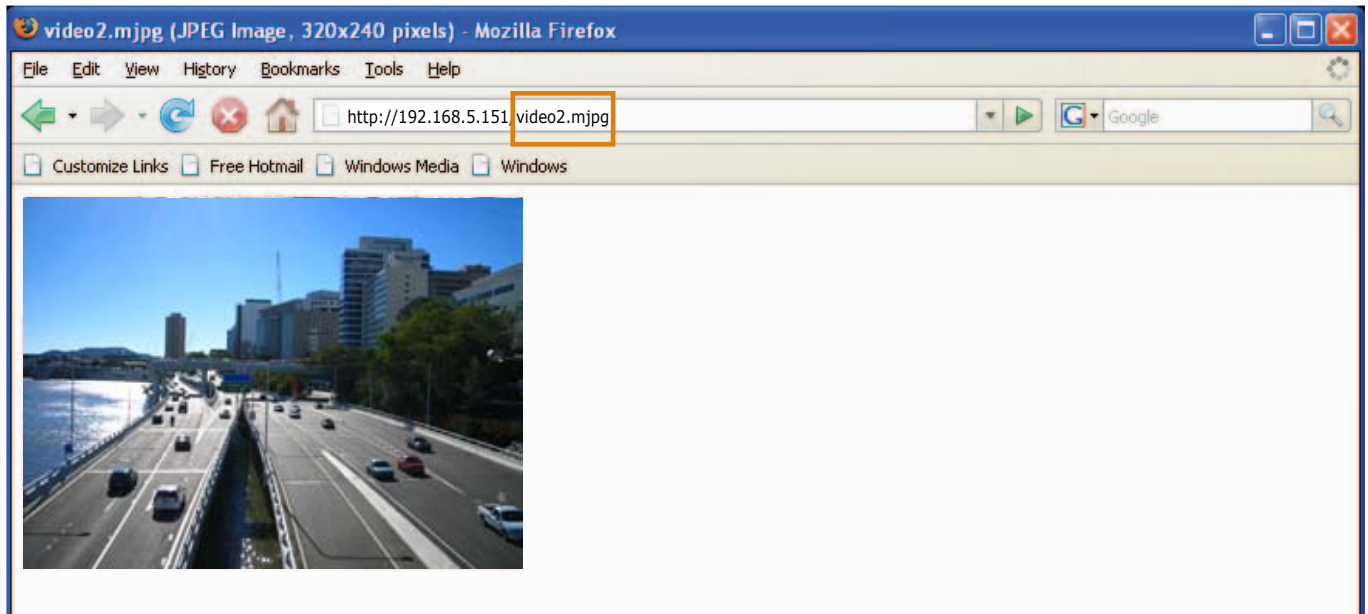

## **NOTE**

- *Microsoft® Internet Explorer does not support server push technology; therefore, using <http://<ip address>:<http port>/<access name for stream1 or stream2>> will fail to access the Network Camera.*

## **HTTPS**

HTTPS	
HTTPS port:	<input type="text" value="443"/>

By default, the HTTPS port is set to 443. It can also be assigned to another port number between 1025 and 65535.

## **FTP**

FTP	
FTP port:	<input type="text" value="21"/>

The FTP server allows the user to save recorded video clips. You can utilize VIVOTEK Installation Wizard 2 to upgrade the firmware via FTP server. By default, the FTP port is set to 21. It also can be assigned to another port number between 1025 and 65535.

## RTSP Streaming

To utilize RTSP streaming authentication, make sure that you have set a password for the Network Camera first; please refer to Security on page 24 for details.

**RTSP Streaming**

Authentication:

Access name for stream 1:

Access name for stream 2:

RTSP port:

RTP port for video:

RTCP port for video:

➤ Multicast settings for stream 1:

➤ Multicast settings for stream 2:

**Authentication:** Depending on your network security requirements, the Network Camera provides three types of security settings for streaming via RTSP protocol: disable, basic, and digest. If **basic** authentication is selected, the password is sent in plain text format, but there can be potential risks of it being intercepted. If **digest** authentication is selected, user credentials are encrypted using MD5 algorithm, thus providing better protection against unauthorized access.

The availability of the RTSP streaming for the three authentication modes is listed in the following table:

	Quick Time player	Real Player
Disable	○	○
Basic	○	○
Digest	○	X

**Access name for stream 1 / Access name for stream 2:** This Network camera supports dual streams simultaneously. The access name is used to differentiate the streaming source. If you want to use an **RTSP player** to access the Network Camera, you have to set the video mode to **MPEG-4** and use the following RTSP URL command to request transmission of the streaming data.

**rtsp://<ip address>:<rtsp port>/<access name for stream1 or stream2>**

For example, when the access name for **stream 1** is set to **live.sdp**:

1. Launch an RTSP player.
2. Choose File > Open URL. A URL dialog box will pop up.
3. Type the URL command in the text box. For example:
4. The live video will be displayed in your player as shown below.

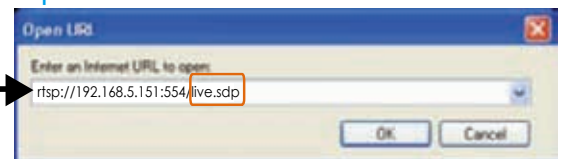

RTSP port /RTP port for video, audio/ RTCP port for video, audio

- RTSP (Real-Time Streaming Protocol) controls the delivery of streaming media. By default, the port number is set to 554.
- The RTP (Real-time Transport Protocol) is used to deliver video and audio data to the clients. By default, the RTP port for video is set to 5556 and the RTP port for audio is set to 5558.
- The RTCP (Real-time Transport Control Protocol) allows the Network Camera to transmit the data by monitoring Internet traffic volume. By default, the RTCP port for video is set to 5557 and the RTCP port for audio is set to 5559.

The ports can be changed to values between 1025 and 65535. The RTP port must be an even number and the RTCP port is the RTP port number plus one, and thus is always odd. When the RTP port changes, the RTCP port will change accordingly.

If the RTP ports are incorrectly assigned, the following warning message will be displayed:



Multicast settings for stream 1 / Multicast settings for stream 2: Click the items to display the detailed configuration information. Select the Always multicast option to enable multicast for stream 1 or stream 2.

▼ Multicast settings for stream 1:

Always multicast

Multicast group address:

Multicast video port:

Multicast RTCP video port:

Multicast TTL [1~255]:

▼ Multicast settings for stream 2:

Always multicast

Multicast group address:

Multicast video port:

Multicast RTCP video port:

Multicast TTL [1~255]:

Unicast video transmission delivers a stream through point-to-point transmission; multicast, on the other hand, sends a stream to the multicast group address and allows multiple clients to acquire the stream at the same time by requesting a copy from the multicast group address. Therefore, enabling multicast can effectively save Internet bandwidth.

The ports can be changed to values between 1025 and 65535. The multicast RTP port must be an even number and the multicast RTCP port number is the multicast RTP port number plus one, and is thus always odd. When the multicast RTP port changes, the multicast RTCP port will change accordingly.

If the multicast RTP video ports are incorrectly assigned, the following warning message will be displayed:



Multicast TTL [1~255]: The multicast TTL (Time To Live) is the value that tells the router the range a packet can be forwarded.

## DDNS

This section explains how to configure the dynamic domain name service for the Network Camera. DDNS is a service that allows your Network Camera, especially when assigned with a dynamic IP address, to have a fixed host and domain name.

### DDNS: Dynamic domain name service

**DDNS: Dynamic domain name service**

Enable DDNS:

Provider:

Host name:

User name:

Password:

**Enable DDNS:** Select this option to enable the DDNS setting.

**Provider:** Select a DDNS provider from the provider drop-down list.

VIVOTEK offers [Safe100.net](#), a free dynamic domain name service, to VIVOTEK customers. It is recommended that you register [Safe100.net](#) to access VIVOTEK's Network Cameras from the Internet. Additionally, we offer other DDNS providers, such as Dyndns.org(Dynamic), Dyndns.org(Custom), TZO.com, DHS.org, CustomSafe100, dyn-interfree.it.

Note that before utilizing this function, please apply for a dynamic domain account first.

#### ■ [Safe100.net](#)

1. In the DDNS column, select [Safe100.net](#) from the drop-down list. Click **I accept** after reviewing the terms of the Service Agreement.
2. In the Register column, fill in the Host name (xxxx.safe100.net), Email, Key, and Confirm Key, then click **Register**. After a host name has been successfully created, a success message will be displayed in the DDNS Registration Result column.

**Register**

Host name:

Email:

Key:

Confirm key:

To apply for a domain name for the camera, or to modify the previously registered information, fill in the following fields and then click "Register".

DDNS Registration Result:

[Register] Successfully Your account information has been mailed to registered e-mail address

Upon successful registration, you can click [copy](#) to automatically upload relevant information to the DDNS form or you can manually fill it in. Then, click "Save" to save new settings.

3. Click **Copy** and all the registered information will automatically be uploaded to the corresponding fields in the DDNS column at the top of the page as seen in the picture.

**DDNS: Dynamic domain name service**

Enable DDNS:

Provider:

Host name:  [\*.safe100.net]

Email:

Key:

---

**Register**

Host name:

Email:

Key:

Confirm key:

To apply for a domain name for the camera, or to modify the previously registered information, fill in the following fields and then click "Register".

DDNS Registration Result:

Upon successful registration, you can click [copy](#) to automatically upload relevant information to the DDNS form or you can manually fill it in. Then, click "Save" to save new settings.

4. Select Enable DDNS and click **Save** to enable the setting.

#### ■ CustomSafe100

VIVOTEK offers documents to establish a CustomSafe100 DDNS server for distributors and system integrators. You can use CustomSafe100 to register a dynamic domain name if your distributor or system integrators offer such services.

1. In the DDNS column, select CustomSafe100 from the drop-down list.
2. In the Register column, fill in the Host name, Email, Key, and Confirm Key; then click **Register**. After a host name has been successfully created, you will see a success message in the DDNS Registration Result column.
3. Click **Copy** and all for the registered information will be uploaded to the corresponding fields in the DDNS column.
4. Select Enable DDNS and click **Save** to enable the setting.

**Forget key:** Click this button if you have forgotten the key to Safe100.net or CustomSafe100. Your account information will be sent to your email address.

Refer to the following links to apply a dynamic domain account when selecting other DDNS providers:

- [Dyndns.org \(Dynamic\) / Dyndns.org \(Custom\)](http://www.dyndns.com/): visit <http://www.dyndns.com/>
- [TZO.com](http://www.tzo.com/): visit <http://www.tzo.com/>
- [DHS.org](http://www.dns.org/): visit <http://www.dns.org/>
- [dyn-interfree.it](http://dyn-interfree.it/): visit <http://dyn-interfree.it/>

## Access List Advanced Mode

This section explains how to control access permission by verifying the client PC's IP address.

### General Settings

**General Settings**

Maximum number of concurrent streaming connection(s) limited to: 10 View Information

Enable access list filtering

Save

Maximum number of concurrent streaming connection(s) limited to: Simultaneous live viewing for 1~10 clients (including stream 1 and stream 2). The default value is 10. If you modify the value and click **Save**, all current connections will be disconnected and automatically attempt to re-link (IE Explore or Quick Time Player).

View Information: Click this button to display the connection status window showing a list of the current connections. For example:

**Connection status**

	IP address	Elapsed time	User ID
<input type="checkbox"/>	192.168.1.147	12:20:34	root
<input type="checkbox"/>	61.22.15.3	00:10:09	
<input type="checkbox"/>	192.168.3.25	45:00:34	greg

Refresh
Add to deny list
Disconnect

- IP address: Current connections to the Network Camera.
- Elapsed time: How much time the client has been at the webpage.
- User ID: If the administrator has set a password for the webpage, the clients have to enter a user name and password to access the live video. The user name will be displayed in the User ID column. If the administrator allows clients to link to the webpage without a user name and password, the User ID column will be empty.

There are some situations which allow clients access to the live video without a user name and password:

1. The administrator does not set up a root password. For more information about how to set up a root password and manage user accounts, please refer to Security on page 24.
2. The administrator has set up a root password, but set **RTSP Authentication** to "disable". For more information about **RTSP Authentication**, please refer to RTSP Streaming on page 36.
3. The administrator has set up a root password, but allows anonymous viewing. For more information about **Allow Anonymous Viewing**, please refer to Security on page 24.



- Refresh: Click this button to refresh all current connections.
- Add to deny list: You can select entries from the Connection Status list and add them to the Deny List to deny access. Please note that those checked connections will only be disconnected temporarily and will automatically try to re-link again (IE Explore or Quick Time Player). If you want to enable the denied list, please check **Enable access list filtering** and click **Save** in the first column.
- Disconnect: If you want to break off the current connections, please select them and click this button. Please note that those checked connections will only be disconnected temporarily and will automatically try to re-link again (IE Explore or Quick Time Player).

Enable access list filtering: Check this item and click **Save** if you want to enable the access list filtering function.

### Filter

There are two lists for permission control: Allowed list and Denied list. Only those clients whose IP addresses are on the Allowed list and not on the Denied list can access the Network Camera.

The screenshot shows a window titled "Filter" with a sub-section "IPv4 access list". It contains two text input fields: "Allowed list" and "Denied list". The "Allowed list" field contains the text "1.0.0.0-255.255.255.255". Below each field are "Add" and "Delete" buttons.

- Add a rule to Allowed/Denied list: Click **Add** to add a rule to Allowed/Denied list.

There are three types of rules for user to set up:

Single: This rule allows the user to add an IP address to the Allowed/Denied list.

For example:

The dialog box is titled "filter address". It has a "Rule:" dropdown menu set to "Single" and an "IP address:" text field containing "192.168.2.1". At the bottom are "OK" and "Cancel" buttons.

Network: This rule allows the user to assign a network address and corresponding subnet mask to the Allow/Deny List.

For example:

The dialog box is titled "filter address". It has a "Rule:" dropdown menu set to "Network" and a "Network address / Network mask" text field containing "192.168.2.0 / 24". At the bottom are "OK" and "Cancel" buttons.

IP address 192.168.2.x will be bolcked.

**Range:** This rule allows the user to assign a range of IP addresses to the Allow/Deny List. This rule is only applied to IPv4.

For example:

**filter address**

Rule: Range 

IP address - IP address  -

■ **Delete Allowed/Denied list:**

In the Delete Allowed List or Delete Denied List column, make a selection and click **Delete**.

**NOTE**

► For example, when the range of IP addresses in the allowed list is set from 1.1.1.0 to 192.255.255.255 and the range in the denied list is set from 1.1.1.0 to 170.255.255.255, only users' IP located between 171.0.0.0 and 192.255.255.255 can access the Network Camera.

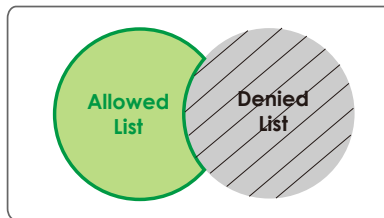

**Administrator IP address**

Always allow the IP address to access this device: You can check this item and add the Administrator's IP address in this field to make sure the Administrator can always connect to the device.

**Administrator IP address**

Always allow the IP address to access this device

## Video

This section explains how to configure the audio and video settings of the Network Camera.

### Video Settings

**Video settings**

Video title:

Color:  ▾

Power line frequency:  ▾

Video orientation:  Flip  Mirror

Maximum Exposure Time:  ▾

Overlay title and time stamp on video and snapshot.

Indoor Mode

✦ Video quality settings for stream 1:

✦ Video quality settings for stream 2:

✦ Day/Night settings:

**Video title:** Enter a name that will be displayed on the title bar of the live video.



**Color:** Select to display color or black/white video streams.

**Power line frequency:** Set the power line frequency consistent with local utility settings to eliminate image flickering associated with fluorescent lights. Note that after the power line frequency is changed, you must disconnect and reconnect the power cord of the Network Camera in order for the new setting to take effect.

**Video orientation:** Flip--vertically reflect the display of the live video; Mirror--horizontally reflect the display of the live video. Select both options if the Network Camera is installed upside-down (ex. on the ceiling) to correct the image orientation.

**Maximum exposure time:** Select a proper maximum exposure time according to the light source of the surroundings. The exposure times are selectable for the following durations: 1/30 second, 1/15 second, and 1/5 second. Shorter exposure times result in less light.

Overlay title and time stamp on video: Select this option to place the video title and time on the video streams.

Note that when the frame size is set to 176 x 144 as shown in the picture below, only the time will be stamped on the video streams.



Indoor Mode: To prevent color rolling effect under fluorescent light, please check this item to adjust the parameter.

[Image Settings](#) **Advanced Mode**

Click **Image Settings** to open the Image Settings page. On this page, you can tune White balance, Brightness, Saturation, Contrast, and Sharpness for the video.



**White Balance**

Auto

**Image Adjustment**

Brightness:  Saturation:

Contrast:  Sharpness:

White balance: Adjust the value for best color temperature.

■ **Auto**

The Network Camera automatically adjusts the color temperature of light in response to different light sources. The white balance setting defaults to Auto and works well in most situations.

- Keep current value

Follow the steps below to manually set the white balance to compensate for the ambient lighting conditions.

1. Set the White balance to Auto and click **Save**.
2. Place a sheet of white paper in front of the lens; then allow the Network Camera to adjust the color temperature automatically.
3. Select Keep current value to confirm the setting while the white balance is being measured.
4. Click **Save** to take effect.

### Image Adjustment

- Brightness: Adjust the image brightness level, which ranges from -5 to +5. The default value is set to 0.
- Saturation: Adjust the image saturation level, which ranges from -5 to +5. The default value is set to 0.
- Contrast: Adjust the image contrast level, which ranges from -5 to +5. The default value is set to 0.
- Sharpness: Adjust the image sharpness level, which ranges from -3 to +3. The default value is set to 0.

You can click **Preview** to fine-tune the image, or click **Restore** to recall the original settings without incorporating the changes. When completed with the settings on this page, click **Save** to enable the setting and click **Close** to exit the page.

### Privacy Mask Advanced Mode

Click **Privacy Mask** to open the settings page. On this page, you can block out sensitive zones to address privacy concerns.

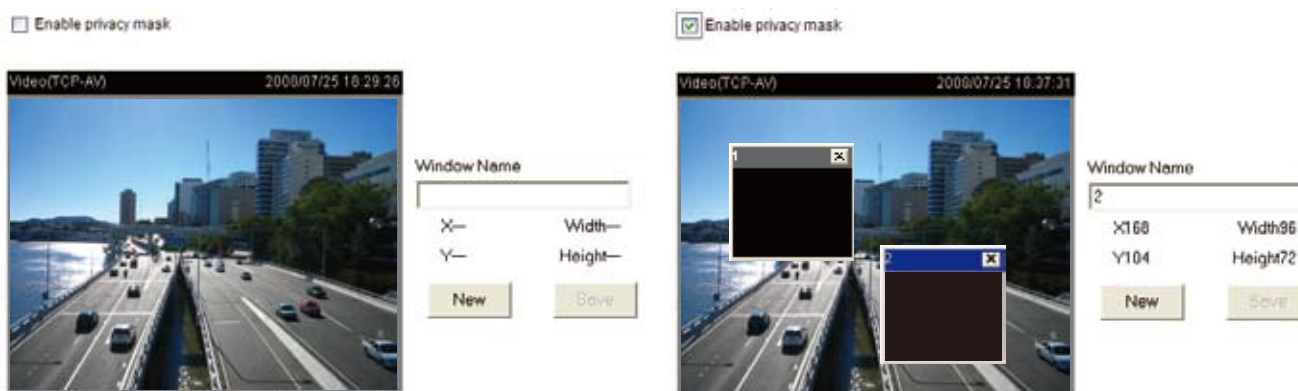

- To set the privacy mask windows, follow the steps below:

1. Click New to add a new window.
2. Use the mouse to size and drag-drop the window, which is recommended to be at least twice the size of the object (height and width) you want to cover.
3. Enter a Window Name and click Save to enable the setting.
4. Select Enable privacy mask to enable this function.

### **NOTE**

- ▶ Up to 5 privacy mask windows can be set up on the same screen.
- ▶ If you want to delete the privacy mask window, please click the 'x' on the upper right-hand corner of the window.

## Video quality settings for stream 1 / stream 2 **Advanced Mode**

The Network Camera offers two choices of video compression standards for real-time viewing: MPEG-4 and MJPEG.

Click the items to display the detailed configuration settings. You can set up two separate streams for the Network Camera for different viewing devices. For example, set a smaller frame size and lower bit rate for remote viewing on mobile phones and a larger video size and a higher bit rate for live viewing on web browsers.

If **MPEG-4** mode is selected, it is streamed in RTSP protocol. There are four parameters provided in MPEG-4 mode which allow you to adjust the video performance:

### Video quality settings for stream 1:

MPEG-4:

Frame size:

Maximum frame rate:  (1~30)

Intra frame period:

Video quality:

Constant bit rate:  (4~4000)

Fixed quality:  (1~31)

JPEG:

### Video quality settings for stream 2:

MPEG-4:

JPEG:

Frame size:

Maximum frame rate:  (1~30)

Video quality:  (10~200)

#### ■ Frame size

Select the video size. Note that a larger frame size takes up more bandwidth. The frame sizes are selectable in the following resolutions: 176 x 144, 320 x 240 and 640 x 480.

#### ■ Maximum frame rate

This limits the maximum refresh frame rate per second. Set the frame rate higher for smoother video quality.

If the power line frequency is set to 50Hz, the frame rates are selectable at 1fps, 2fps, 3fps, 5fps, 8fps, 10fps, 15fps, 20fps, and 25fps. If the power line frequency is set to 60Hz, the frame rates are selectable at 1fps, 2fps, 3fps, 5fps, 8fps, 10fps, 15fps, 20fps, 25fps, and 30fps. You can also select Customize and manually enter a value.

#### ■ Intra frame period

Determine how often to plant an I frame. The shorter the duration, the more likely you will get better video quality, but at the cost of higher network bandwidth consumption. Select the intra frame period from the following durations: 1/4 second, 1/2 second, 1 second, 2 seconds, 3 seconds, and 4 seconds.

#### ■ Video quality

A complex scene generally produces a larger file size, meaning that higher bandwidth will be needed for data transmission. Therefore, if **Constant bit rate** is selected, the bandwidth utilization is fixed at a selected level, resulting in mutable video quality performance. The bit rates are selectable at the following rates: 20Kbps, 30Kbps, 40Kbps, 50Kbps, 64Kbps, 128Kbps, 256Kbps, 512Kbps, 768Kbps, 1Mbps, 2Mbps, 3Mbps, and 4Mbps. You can also select **Customize** and manually enter a value.

On the other hand, if **Fixed quality** is selected, all frames are transmitted with the same quality; bandwidth utilization is therefore unpredictable. The video quality can be adjusted to the following settings: Medium, Standard, Good, Detailed, and Excellent. You can also select **Customize** and manually enter a value.

If **JPEG** mode is selected, the Network Camera continuously sends JPEG images to the client, producing a moving effect similar to a filmstrip. Every single JPEG image transmitted guarantees the same image quality, which in turn comes at the expense of variable bandwidth usage. Because the media contents are a combination of JPEG images, no audio data is transmitted to the client. There are three parameters provided in MJPEG mode to control the video performance:

#### ■ Frame size

Select the video size. Note that a larger frame size takes up more bandwidth. The frame sizes are selectable in the following resolutions: 176 x 144, 320 x 240 and 640 x 480.

#### ■ Maximum frame rate

This limits the maximal refresh frame rate per second. Set the frame rate higher for a smoother video quality.

If the power line frequency is set to 50Hz, the frame rates are selectable at the following rates: 1fps, 2fps, 3fps, 5fps, 8fps, 10fps, 15fps, 20fps and 25fps. If the power line frequency is set to 60Hz, the frame rates are selectable at the following rates: 1fps, 2fps, 3fps, 5fps, 8fps, 10fps, 15fps, 20fps, 25fps and 30fps. You can also select **Customize**, and manually enter a value.

#### ■ Video quality

The video qualities are selectable at the following settings: Medium, Standard, Good, Detailed and Excellent. You can also select **Customize**, and manually enter a value.

### **NOTE**

- *The value of video quality and fixed quality refers to the **compression rate**, so the lower value will produce the higher quality.*

### Day/Night Settings

#### ▼ Day/Night settings:

Switch to B/W in night mode

IR LED:

Light sensor sensitivity:

Disable IR LED

#### Switch to B/W in night mode

Select this to enable the Network Camera to automatically switch to B/W during night mode.

## IR LED

With built-in IR illuminators, up to 15m, this Network Camera can make use of IR light during low light conditions.

The IR LED supports five modes, Auto, Day, Night, Schedule and Disabled.

- **Auto mode**  
The Network Camera automatically control the IR LED by judging the level of ambient light.
- **Day mode**  
Select "Day mode" to turn on the IR LED.
- **Night mode**  
Select "Night mode" to turn off the IR LED.
- **Schedule mode**  
Select "Schedule mode" to control the IR LED by schedule. Enter the start and end time for day mode. Note that the time format is [hh:mm] and is expressed in 24-hour clock time. By default, the start and end time of day mode are set to 07:00 and 18:00.

### Light sensor sensitivity

Select Low, Normal, or High for the light sensor sensibility.

### Disable IR LED

If you do not want to use the IR illuminators, you can select this option to turn it always off.



## Motion Detection

This section explains how to configure the Network Camera to enable motion detection. A total of three motion detection windows can be configured.



Motion Detection Setting 1: for normal situation

Motion Detection Setting 2: for special situation

Follow the steps below to enable motion detection:

1. Click **New** to add a new motion detection window.
2. In the Window Name text box, enter a name for the motion detection window.
  - To move and resize the window, drag and drop your mouse on the window.
  - To delete window, click X on the top right corner of the window.
3. Define the sensitivity to moving objects and the space ratio of all alerted pixels by moving the Sensitivity and Percentage slider bar.
4. Click **Save** to enable the settings.
5. Select **Enable motion detection** to enable this function.

For example:

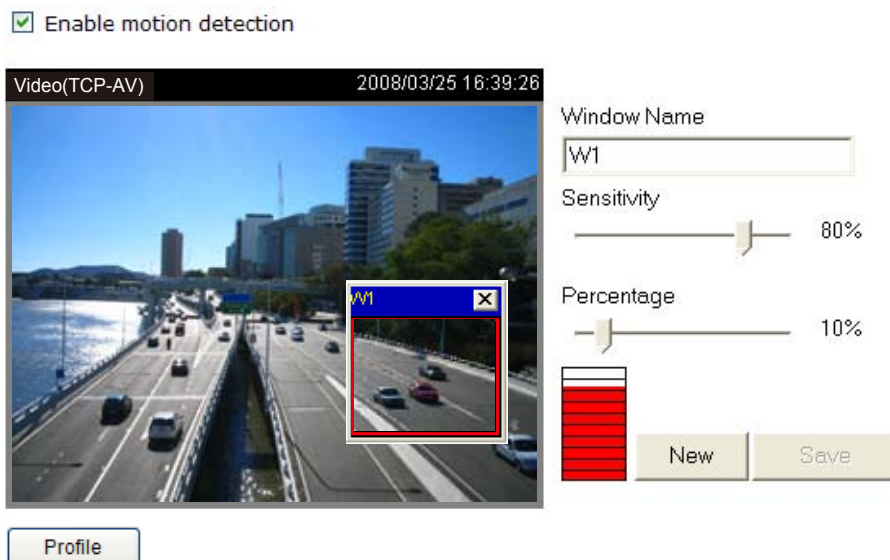

The Percentage Indicator will rise or fall depending on the variation between sequential images. When motions are detected by the Network Camera and are judged to exceed the defined threshold, the red bar rises. Meanwhile, the motion detection window will be outlined in red. Photos or videos can be captured instantly and configured to be sent to a remote server (Email, FTP) by utilizing this feature as a trigger source. For more information on how to set an event, please refer to Application on page 56.

A green bar indicates that even though motions have been detected, the event has not been triggered because the image variations still fall under the defined threshold.

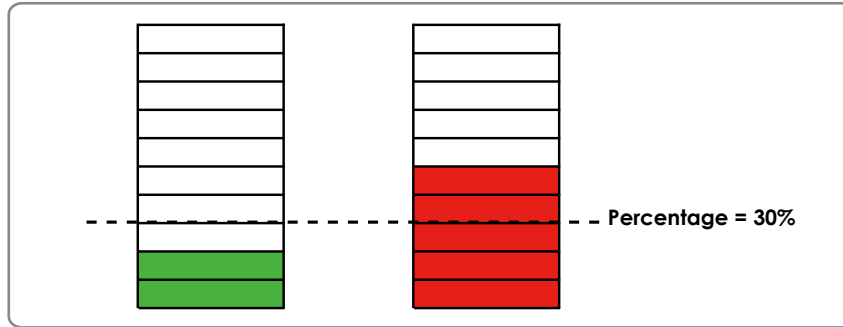

If you want to configure other motion detection settings for day/night/schedule mode, please click **Profile** to open the Motion Detection Profile Settings page as shown below. A total of three motion detection windows can be configured on this page as well.

The screenshot shows the Motion Detection Profile Settings page. It features a video feed of a bridge over water, a 'Window Name' field, 'Sensitivity' and 'Percentage' sliders set to 0%, and a 'General Settings' section with 'Enable this profile' checked and 'Night mode' selected.

Please follow the steps below to set up a profile:

1. Create a new motion detection window.
2. Check Enable this profile.
3. Select the applicable mode: Day mode, Night mode, or Schedule mode. Please manually enter a time range if you choose Schedule mode.
4. Click Save to enable the settings and click **Close** to exit the page.  
This motion detection window will also be displayed on the Event Settings page. You can go to Application > Event Settings > Trigger to choose it as a trigger source. Please refer to page 58 for detailed information.

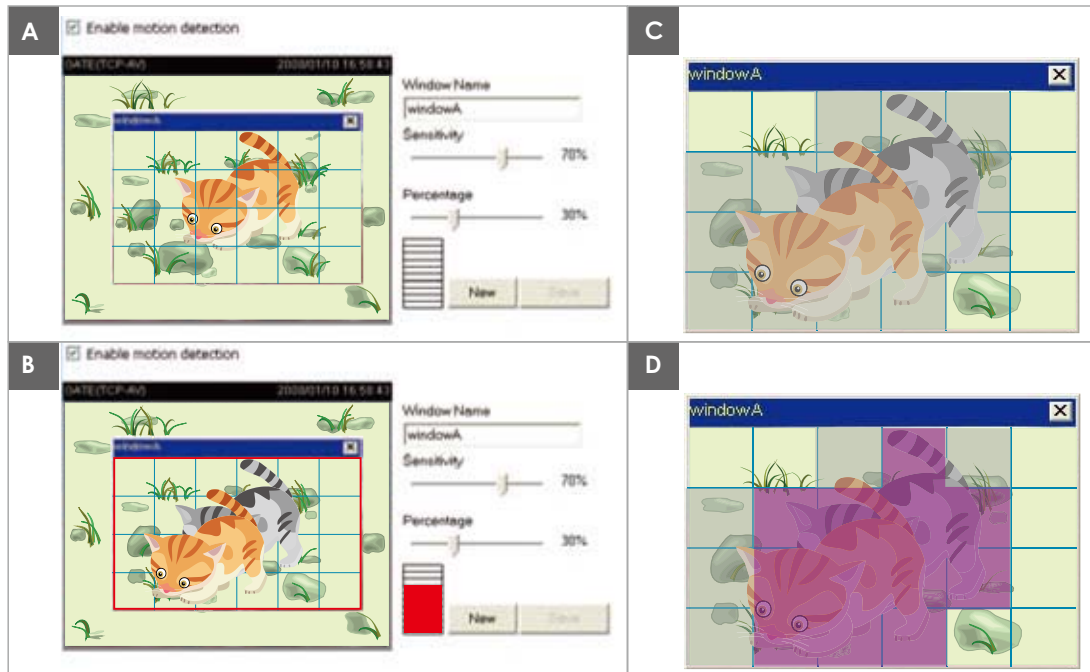
**NOTE**► *How does motion detection work?*

There are two motion detection parameters: *Sensitivity* and *Percentage*. In the illustration above, frame A and frame B are two sequential images. Pixel differences between the two frames are detected and highlighted in gray (frame C) and will be compared with the sensitivity setting. *Sensitivity* is a value that expresses the sensitivity to moving objects. Higher sensitivity settings are expected to detect slight movements while smaller sensitivity settings will neglect them. When the sensitivity is set to 70%, the Network Camera defines the pixels in the purple areas as “alerted pixels” (frame D).

*Percentage* is a value that expresses the proportion of “alerted pixels” to all pixels in the motion detection window. In this case, 50% of pixels are identified as “alerted pixels”. When the percentage is set to 30%, the motions are judged to exceed the defined threshold; therefore, the motion window will be outlined in red.

For applications that require a high level of security management, it is suggested to use higher sensitivity settings and smaller percentage values.

## Camera Tampering Detection

This section explains how to set up camera temper detection. With tamper detection, the camera is capable of detecting incidents such as **redirection, blocking or defocusing**, or even **spray paint**.



The screenshot shows a settings window for camera tampering detection. It contains a checked checkbox labeled "Enable camera tampering detection". Below this is a text input field for "Trigger duration" with the value "10" and the unit "seconds [10~600]". At the bottom left of the window is a "Save" button.

Please follow the steps below to set up the camera tamper detection function:

1. Check Enable camera tampering detection.
2. Enter the tamper trigger duration. (10 sec. ~ 10 min.) The tamper alarm will be triggered only when the tampering factor (the difference between current frame and pre-saved background) exceeds the trigger threshold.
3. Set up the event source as Camera Tampering Detection on Application page > Event Settings / Server Settings (how to send alarm message) / Media Settings (send what type of alarm message). Please refer to page 65 for detailed information.

## Homepage Layout Advanced Mode

This section explains how to set up your own customized homepage layout.

### Preview

This column shows the settings of your homepage layout. You can manually select the background and font colors in Theme Options, the third column on this page. The settings will automatically show up in this Preview field. The following shows the homepage using the default settings:

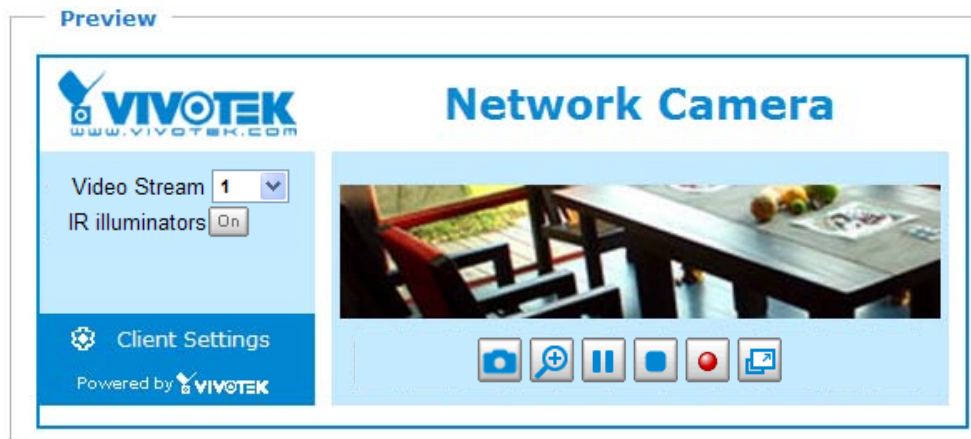



### Logo

Here you can change the logo at the top of your homepage.

**Logo graph**

You can upload a small logo(Gif, JPG or PNG), which will be resized to 160x50 pixels (if it is not already that size) and which will be visible on the main page. Upload a new logo will replace the old custom logo (if there was one uploaded)

Default
  Custom

Logo link:

Follow the steps below to upload a new logo:

1. Click **Custom** and the Browse field will appear.
2. Select a logo from your files.
3. Click **Upload** to replace the existing logo with a new one.
4. Enter a website link if necessary.
5. Click **Save** to enable the settings.

## Theme Options

Here you can change the color of your homepage layout. There are three types of preset patterns for you to choose from. The new layout will simultaneously appear in the **Preview** filed. Click **Save** to enable the settings.

**Theme Options**

**Themes**







Custom

**Color:**

Font color:

Font color of configuration area:

Font color of video title:

Bk color of control area:

Bk color of configuration area:

Bk color of video area:

Frame color:

**Preview**

Font Color

Background Color of the Control Area

Font Color of the Configuration Area

Background Color of the Configuration Area



Font Color of the Video Title

Background Color of the Video Area

Frame Color

  

**Preview**



**Preview**



- Follow the steps below to set up the customized homepage:
  - Click **Custom** on the left column.
  - Click the field where you want to change the color on the right column.

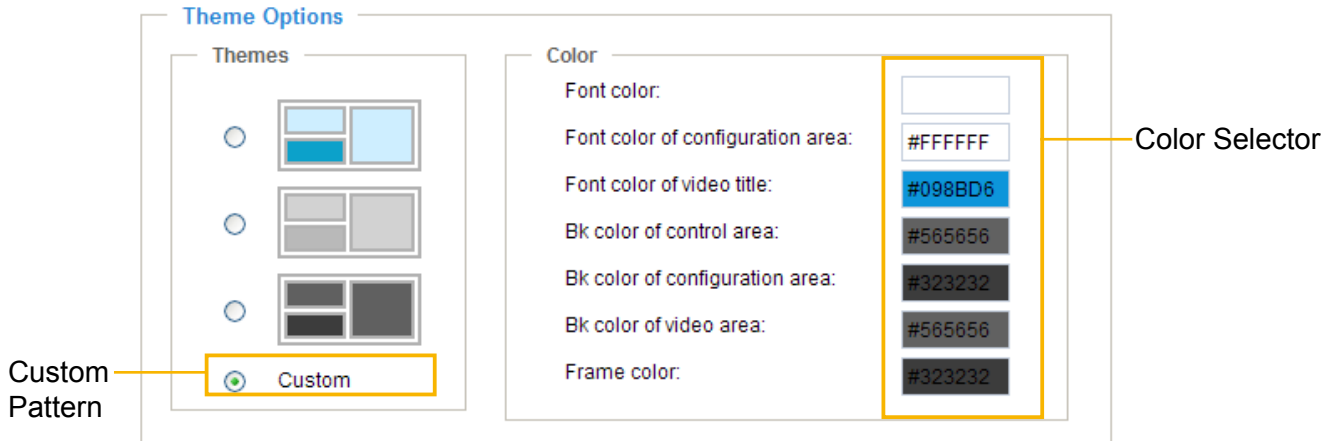

- The palette window will pop up as shown below.

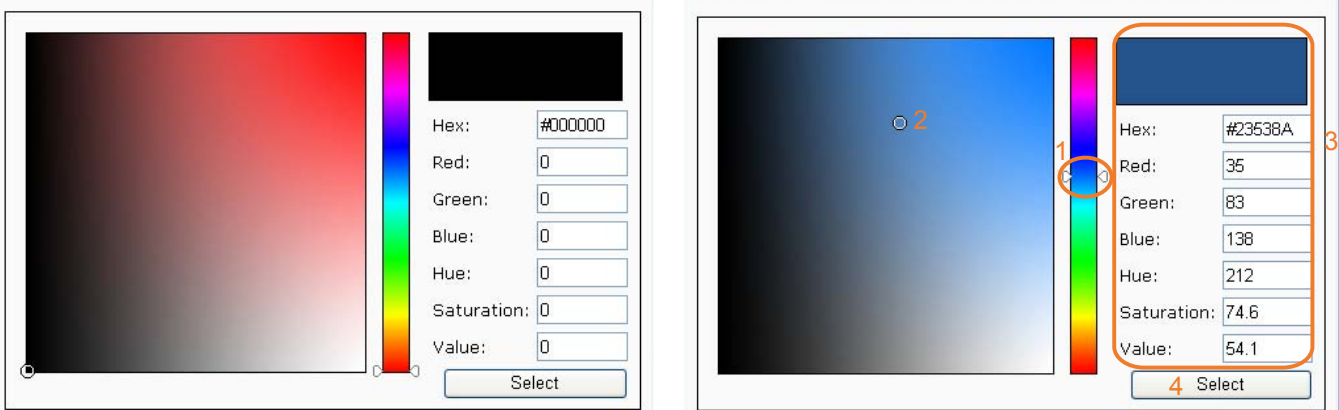

- Drag the slider bar and click on the left square to select a desired color.
- The selected color will show up in the corresponding fields and in the **Preview** column.
- Click **Save** to enable the settings.

## Application Advanced Mode

This section explains how to configure the Network Camera to react in response to particular situations (event). A typical application is that when a motion is detected, the Network Camera sends buffered images to a FTP server or e-mail address as notifications.

In the illustration on the right, an event can be triggered by many sources, such as motion detection or external digital input devices. When an event is triggered, you can specify what type of action that will be performed. You can configure the Network Camera to send snapshots or videos to your email address or FTP site.

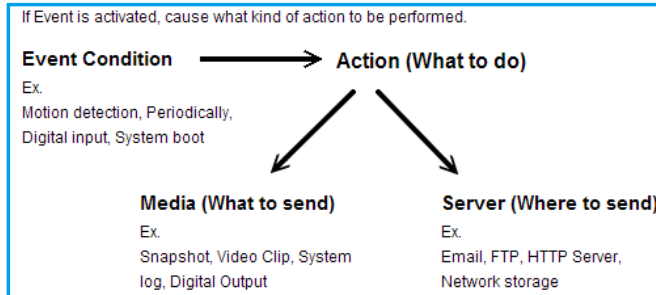

**Event Settings**

Name	Status	Sun	Mon	Tue	Wed	Thu	Fri	Sat	Time	Trigger
<input type="button" value="Add"/> <input type="button" value="Help"/>										

**Customized Script**

Name	Date	Time
<input type="button" value="Add"/> <input type="button" value="▼"/> <input type="button" value="Delete"/>		

### Customized Script

This function allows you to upload a sample script (.xml file) to the webpage, which will save your time on configuring the settings. Please note that there is a limited number of customized scripts you can upload; if the current amount of customized scripts has reached the limit, an alert message will pop up. If you need more information, please ask for VIVOTEK's technical support.

**Customized Script**

Name	Date	Time
<a href="#">User1</a>	20081113	18:13:46
<a href="#">User2</a>	20081113	18:11:32
<input type="button" value="Add"/> <input type="button" value="User1"/> <input type="button" value="▼"/> <input type="button" value="Delete"/>		

`<?xml version="1.0" encoding="UTF-8"?>`  
`<eventmgr version="0102"?>`  
`<maxprocess>1</maxprocess>`  
`<!-- From 08:30:00-20:30:00 on Monday to Friday every week -->`  
`<schedule id="0"?>`  
`<duration>`  
`<weekday>1-5</weekday>`  
`<time>08:30:00-20:30:00</time>`  
`</duration>`  
`</schedule>`  
`<!-- Motion -->`  
`<action condition="0"?>`  
`<status id="0">trigger</status>`  
`<status id="1">trigger</status>`  
`</action>`  
`<event id="0">`  
`<description>Mail system log to email address</description>`  
`<condition>0</condition>`  
`<scheduleno>0</scheduleno>`  
`<delay>10</delay>`  
`<!-- users can send email with title "Motion" to recipient guoding.yang@vivotek.com. The body of mail is the log messages -->`  
`<process>`  
`/usr/bin/sempollent -s "Motion" -f IP@199@vivotek.com -b /var/log/messages -S ma.vivotek.tw -H 3 guoding.yang@vivotek.com`  
`</process>`  
`<priority>0</priority>`  
`</event>`  
`</eventmgr>`

Click to upload a file. Add

Click to modify the script online User1



## Event Settings

In the **Event Settings** column, click **Add** to open the **Event Settings** page. On this page, you can arrange three elements -- Trigger, Schedule, and Action to set an event. A total of 3 event settings can be configured.

Event name:

Enable this event

Priority:  ▾

Detect next event after  second(s).

Note: This can only applied to motion detection and digital input

**Trigger**

Video motion detection:

Periodically:

Digital input

System boot

Recording notify

Camera tampering detection:

**Event Schedule**

Sun  Mon  Tue  Wed  Thu  Fri  Sat

**Time**

Always

From  to  [hh:mm]

**Action**

Turn on IR illuminators for  seconds  ▾

Server	Media	Extra parameter

Event name: Enter a name for the event setting.

Enable this event: Select this option to enable the event setting.

Priority: Select the relative importance of this event (High, Normal, or Low). Events with a higher priority setting will be executed first.

Detect next event after  seconds: Enter the duration in seconds to pause motion detection after a motion is detected.

An event is an action initiated by a user-defined trigger source; it is the causal arrangement of the following three elements: Trigger, Event Schedule, and Action.

**Trigger**

This is the cause or stimulus which defines when to trigger the Network Camera. The trigger source can be configured to use the Network Camera's built-in motion detection mechanism or external digital input devices.

There are several choices of trigger sources as shown below. Select the items to display the detailed configuration options.

■ Video motion detection

This option makes use of the built-in motion detection mechanism as a trigger source. To enable this function, you need to configure a Motion Detection Window first. For more information, please refer to Motion detection on page 49 for details.

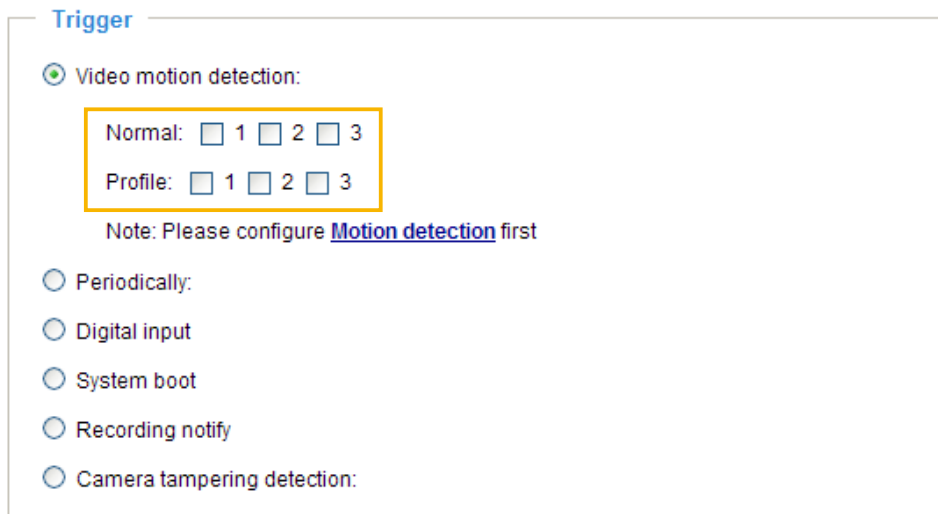

■ Periodically

This option allows the Network Camera to trigger periodically for every other defined minute. Up to 999 minutes are allowed.

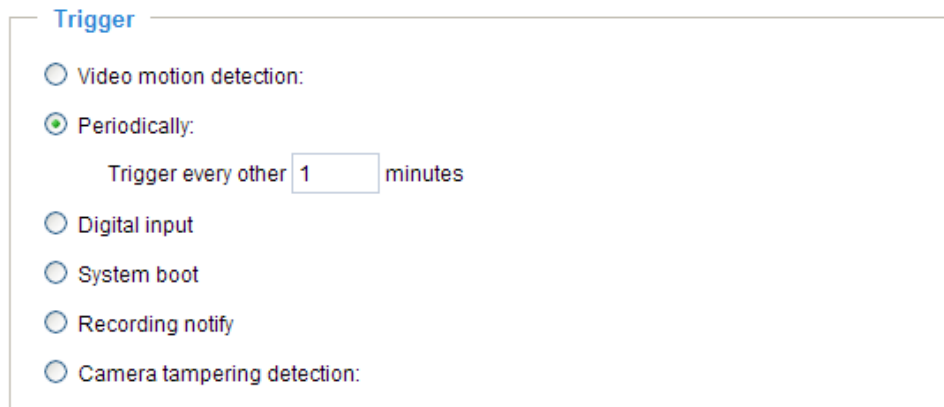

■ Digital input

This option allows the Network Camera to use an external digital input device or sensor as a trigger source. Depending on your application, there are many choices of digital input devices on the market which helps to detect changes in temperature, vibration, sound and light, etc.

■ System boot

This option triggers the Network Camera when the power to the Network Camera is disconnected.

■ Recording notify

This option allows the Network Camera to trigger when the recording disk is full or when recording starts to rewrite older data. If you want receive **Recording notify message**, please refer to page 67 for detailed information.

■ Camera tampering detection

This option allows the Network Camera to trigger when the camera detects that it is being tampered with. To enable this function, you need to configure the Tampering Detection option first. Please refer to page 52 for detailed information.

**Trigger**

Video motion detection:

Periodically:

Digital input

System boot

Recording notify

Camera tampering detection:

Note: Please configure [Camera tampering detection](#) first

Event Schedule

Specify the period for the event.

**Event Schedule**

Sun  Mon  Tue  Wed  Thu  Fri  Sat

**Time**

Always

From  to  [hh:mm]

- Select the days of the week.
- Select the recording schedule in 24-hr time format.

Action

Define the actions to be performed by the Network Camera when a trigger is activated.

**Action**

Turn on IR illuminators for  seconds

Server	Media	Extra parameter

- Turn on IR Illuminators for  seconds  
 Select this to turn on IR Illuminators when a trigger is activated every time or only in low light conditions. Specify the length of trigger interval in the text box.

To set an event with recorded video or snapshots, it is necessary to configure the server and media settings so that the Network Camera will know what action to take (such as which server to send the media files to) when a trigger is activated.

■ Add Server / Add Media

Click **Add Server** to configure [Server Settings](#). For more information, please refer to Server Settings on page 62.

Click **Add Media** to configure [Media Settings](#). For more information, please refer to Media Settings on page 65.

Here is an example of Event Settings page:

Event name:

Enable this event

Priority:  ▾

Detect next event after  second(s).

Note: This can only be applied to motion detection and digital input

**Trigger**

Video motion detection:

Periodically:

Digital input

System boot

Recording notify

Camera tampering detection:

Note: Please configure [Camera tampering detection](#) first

**Event Schedule**

Sun  Mon  Tue  Wed  Thu  Fri  Sat

**Time**

Always

From  to  [hh:mm]

**Action**

Trigger digital output for  seconds

Server	Media	Extra parameter
<input checked="" type="checkbox"/> NAS	<input type="text" value="Video Clip"/> ▾	<input checked="" type="checkbox"/> Create folders by date time and hour automatically <input type="button" value="View"/>
<input type="checkbox"/> FTP	<input type="text" value="----None-----"/> ▾	
<input type="checkbox"/> Email	<input type="text" value="----None-----"/> ▾	
<input type="checkbox"/> HTTP	<input type="text" value="----None-----"/> ▾	

When completed, click **Save** to enable the settings and click **Close** to exit Event Settings page. The new event settings / server settings / media settings will appear in the event drop-down list on the Application page.

Here is an example of Application page with an event setting:

**Event Settings**

Name	Status	Sun	Mon	Tue	Wed	Thu	Fri	Sat	Time	Trigger
<a href="#">Event1</a>	<a href="#">ON</a>	V	V	V	V	V	V	V	00:00~24:00	tampering

**Server Settings**

Name	Type	Address/Location
<a href="#">NAS</a>	ns	\\192.168.5.122\inas
<a href="#">FTP</a>	ftp	ftp.vivotek.com
<a href="#">Email</a>	email	Ms.vivotek.tw
<a href="#">HTTP</a>	http	http://192.168.3.10/cgi-bin/upload.cgi

**Media Settings**

Available memory space: 3550KB

Name	Type
<a href="#">Snapshot</a>	snapshot
<a href="#">Video Clip</a>	videoclip
<a href="#">Recording notify</a>	recordmsg
<a href="#">System log</a>	systemlog

**Customized Script**

Name	Date	Time
------	------	------

When the Event Status is **ON**, once an event is triggered by motion detection, the Network Camera will automatically send snapshots via e-mail.

If you want to stop the event trigger, you can click **ON** to turn it to **OFF** status or click **Delete** to remove the event setting.

To remove a server setting from the list, select a server name from the drop-down list and click **Delete**. Note that only when the server setting is not being applied to an event setting can it be deleted.

To remove a media setting from the list, select a media name from the drop-down list and click **Delete**. Note that only when the media setting is not being applied to an event setting can it be deleted.

## Server Settings

Click **Add Server** on Event Settings page to open the Server Setting page. On this page, you can specify where the notification messages are sent when a trigger is activated. A total of 5 server settings can be configured.

**Server name:** Enter a name for the server setting.

### Server Type

There are four choices of server types available: Email, FTP, HTTP, and Network storage. Select the item to display the detailed configuration options. You can configure either one or all of them.

**Email:** Select to send the media files via email when a trigger is activated.

Server name:

**Server Type**

Email:

Sender email address:

Recipient email address:

Server address:

User name:

Password:

Server port:

This server requires a secure connection (SSL)

FTP:

HTTP:

Network storage:

- Sender email address: Enter the email address of the sender.
- Recipient email address: Enter the email address of the recipient.
- Server address: Enter the domain name or IP address of the email server.
- User name: Enter the user name of the email account if necessary.
- Password: Enter the password of the email account if necessary.
- Server port: The default mail server port is set to 25. You can also manually set another port.

If your SMTP server requires a secure connection (SSL), check **This server requires a secure connection (SSL)**.

To verify if the email settings are correctly configured, click **Test**. The result will be shown in a pop-up window. If successful, you will also receive an email indicating the result.

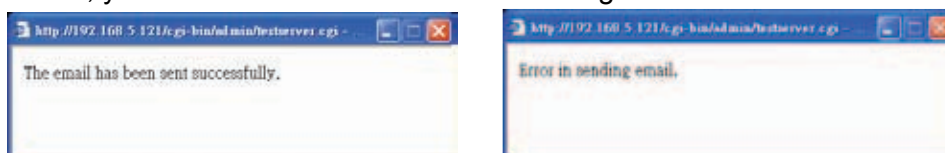

Click **Save** to enable the settings, then click **Close** to exit the page.

**FTP:** Select to send the media files to an FTP server when a trigger is activated.

Server name:

**Server Type**

Email:

**FTP:**

Server address:

Server port:

User name:

Password:

FTP folder name:

Passive mode

HTTP:

Network storage:

- **Server address:** Enter the domain name or IP address of the FTP server.
- **Server port**  
By default, the FTP server port is set to 21. It can also be assigned to another port number between 1025 and 65535.
- **User name:** Enter the login name of the FTP account.
- **Password:** Enter the password of the FTP account.
- **FTP folder name**  
Enter the folder where the media file will be placed. If the folder name does not exist, the Network Camera will create one on the FTP server.
- **Passive mode**  
Most firewalls do not accept new connections initiated from external requests. If the FTP server supports passive mode, select this option to enable passive mode FTP and allow data transmission to pass through the firewall.

To verify if the FTP settings are correctly configured, click **Test**. The result will be shown in a pop-up window as shown below. If successful, you will also receive a test.txt file on the FTP server.

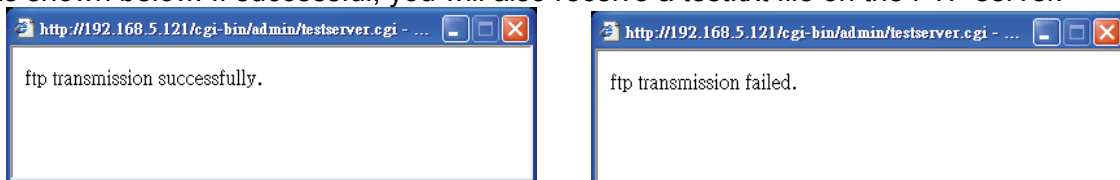

Click **Save** to enable the settings, then click **Close** to exit the page.

**HTTP:** Select to send the media files to an HTTP server when a trigger is activated.

Server name:

**Server Type**

Email:

FTP:

HTTP:

URL:

User name:

Password:

Network storage:

- URL: Enter the URL of the HTTP server.
- User name: Enter the user name if necessary.
- Password: Enter the password if necessary.

To verify if the HTTP settings are correctly configured, click **Test**. The result will be shown in a pop-up window as below. If successful, you will receive a test.txt file on the HTTP server.



Click **Save** to enable the settings, then click **Close** to exit the page.

**Network storage:** Select to send the media files to a network storage location when a trigger is activated. Please refer to **Network Storage Setting** on page 69 for details.

Click **Save** to enable the settings, then click **Close** to exit the page.

When completed, the new server settings will automatically be displayed on the Event Settings page. For example:

	Server	Media	Extra parameter
<input type="checkbox"/>	FTP	----None----	
<input type="checkbox"/>	Email	----None----	
<input type="checkbox"/>	HTTP	----None----	
<input type="checkbox"/>	NAS	----None----	<input type="checkbox"/> Create folders by date time and hour automatically



## Media Settings

Click **Add Media** on the Event Settings page to open the Media Settings page. On this page, you can specify the type of media that will be sent when a trigger is activated. A total of 5 media settings can be configured.

**Media name:** Enter a name for the media setting.

### Media Type

There are three choices of media types available: Snapshot, Video clip, and System log. Select the item to display the detailed configuration options. You can configure either one or all of them.

**Snapshot:** Select to

Media name:

**Media Type**

Snapshot

Source:  ▼

Send  pre-event image(s) [0~7]

Send  post-event image(s) [0~7]

File name prefix:

Add date and time suffix to file name

Video Clip

System log

Recording notify message

- Source: Select to take snapshots from stream 1 or stream 2.
- Send  pre-event images  
The Network Camera has a buffer area; it temporarily holds data up to a certain limit. Enter a number to decide how many images to capture before a trigger is activated. Up to 7 images can be generated.
- Send  post-event images  
Enter a number to decide how many images to capture after a trigger is activated. Up to 7 images can be generated.

For example, if both the Send pre-event images and Send post-event images are set to 7, a total of 15 images are generated after a trigger is activated.

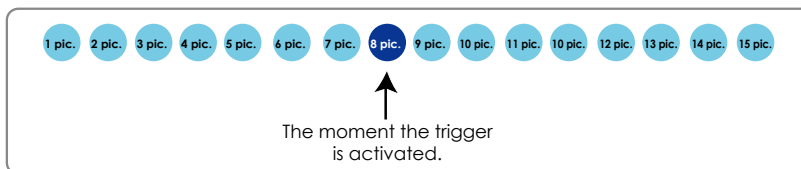

- File name prefix  
Enter the text that will be appended to the front of the file name.
- Add date and time suffix to the file name  
Select this option to add a date/time suffix to the file name.  
For example:



Click **Save** to enable the settings, then click **Close** to exit the page.

**Video clip:** Select to send video clips when a trigger is activated.

Media name:

**Media Type**

Snapshot

Video Clip

Source:  ▼

Pre-event recording:  seconds [0~9]

Maximum duration:  seconds [1~10]

Maximum file size:  Kbytes [50~800]

File name prefix:

System log

Recording notify message

- **Source:** Select to record video clips from stream 1 or stream 2.
- **Pre-event recording**  
The Network Camera has a buffer area; it temporarily holds data up to a certain limit. Enter a number to decide the duration of recording before a trigger is activated. Up to 9 seconds can be set.
- **Maximum duration**  
Specify the maximum recording duration in seconds. Up to 10 seconds can be set.  
For example, if pre-event recording is set to five seconds and the maximum duration is set to ten seconds, the Network Camera continues to record for another 4 seconds after a trigger is activated.

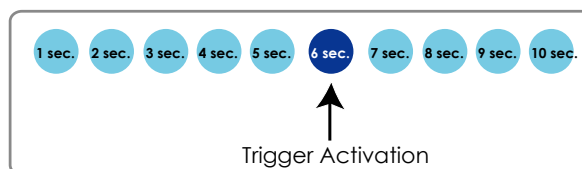

- **Maximum file size**  
Specify the maximum file size allowed.
- **File name prefix**  
Enter the text that will appended to the front of the file name.  
For example:

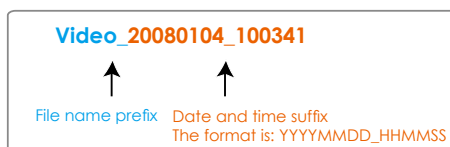

Click **Save** to enable the settings, then click **Close** to exit the page.

**System log:** Select to send a system log when a trigger is activated.  
Click **Save** to enable the settings, then click **Close** to exit the page.

**Recording notify message:** Select to send a recording notify message when a trigger is activated. Following is an example of recording notify message (.txt file), which shows a list of deleted recorded data due to cycle recording.

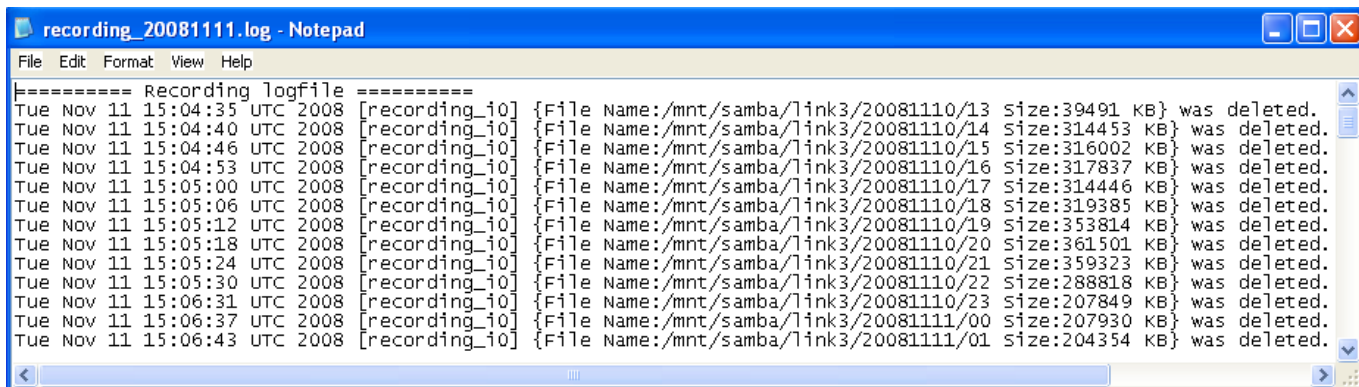

When completed, click **Save** to take effect and then click **Close** to quit this page. The new media settings will show up on the Event Settings page.

Then you can continue to select a server and media type for the event.

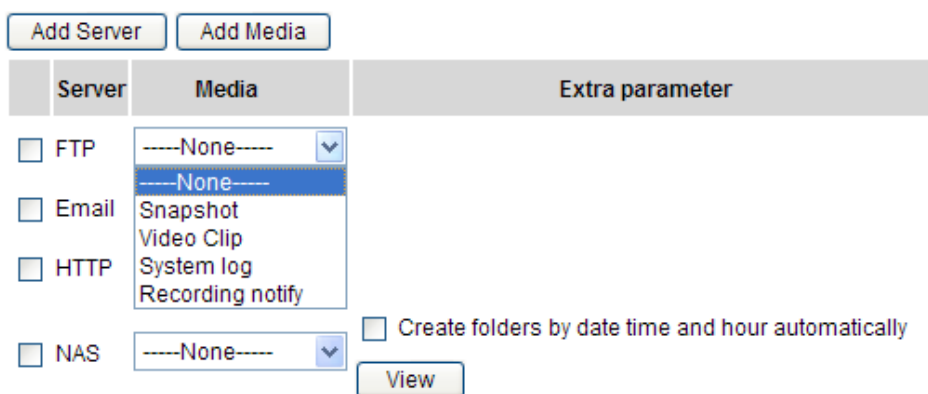

- **Create folders by date, time, and hour automatically:** If you check this item, the system will generate folders automatically by date.
- **View:** Click this button to open a file list window. This function is only for Network Storage. The following is an example of a file destination with video clips:

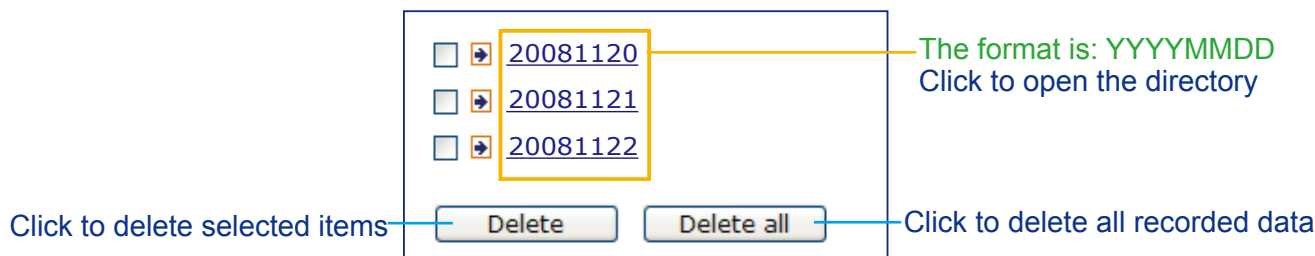

Click [20081120](#) to open the directory:

**The format is: HH (24r)**

Click to open the file list of that hour

< [07](#) [08](#) [09](#) [10](#) [11](#) [12](#) [13](#) [14](#) [15](#) [16](#) [17](#) >

	file name	size	date	time
<input type="checkbox"/>	<a href="#">Recording1 58.mp4</a>	2526004	2008/11/20	07:58:28
<input type="checkbox"/>	<a href="#">Recording1 59.mp4</a>	2563536	2008/11/20	07:59:28

Click to delete selected items

Click to go back to the previous level of the directory

Click to delete all recorded data

< [07](#) [08](#) [09](#) [10](#) [11](#) [12](#) [13](#) [14](#) [15](#) [16](#) [17](#) >

	file name	size	date	time
<input type="checkbox"/>	<a href="#">Recording1 58.mp4</a>	2526004	2008/11/20	07:58:28
<input type="checkbox"/>	<a href="#">Recording1 59.mp4</a>	2563536	2008/11/20	07:59:28

**The format is: File name prefix + Minute (mm)**

You can set up the File name prefix on Media Settings page.

Please refer to page 65 for detailed information.

## Recording Advanced Mode

This section explains how to configure the recording settings for the Network Camera.

### Recording Settings

**Recording Settings**

Note: Before setup recording, you have to setup network storage first via [Server](#) page

Name	Status	Sun	Mon	Tue	Wed	Thu	Fri	Sat	Time	Source	Destination
<div style="display: flex; justify-content: space-between; align-items: center;"> <span>Add</span> <span>▼</span> <span>Delete</span> </div>											

#### ***NOTE***

► Before setting up this page, please set up the Network Storage on the Server Settings page first.

#### **Network Storage Setting**

Click [Server](#) to open the Server Settings page and follow the steps below to set up:

1. Fill in the information for your server.

For example:

**>Server Settings**

Server name:  3

**Server Type**

Email:

FTP:

HTTP:

1  **Network storage:**

Network storage location:  the path of the network storage  
(\\server name or IP address\folder name)

(For example:  
\\my\_nas\disk\folder)

Workgroup:

User name:  the user name and password of  
your server

Password:

2 4

2. Click **Test** to check the setting. The result will be shown in the pop-up window.

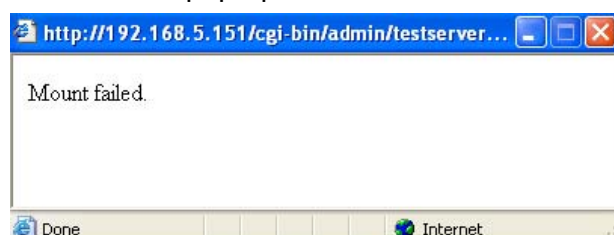
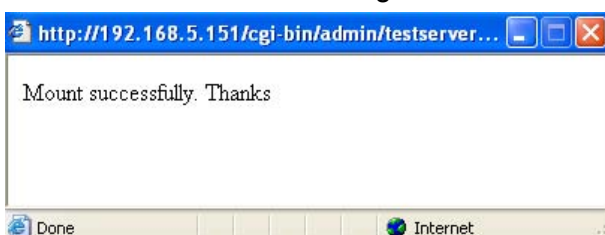

If successful, you will receive a test.txt file on the network storage server.

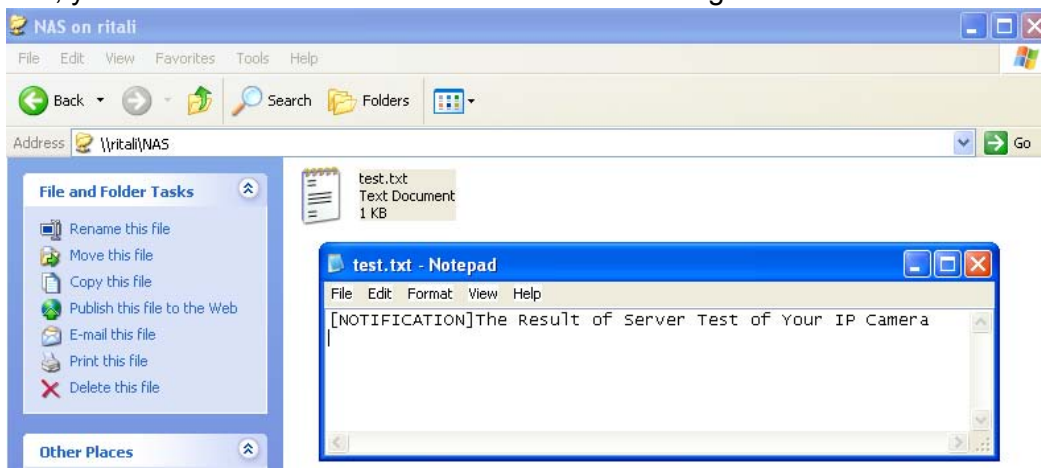

3. Enter a server name.

4. Click **Save** to complete the settings and click **Close** to exit the page.

### Recording Settings

Click **Add** to open the recording setting page. On this page, you can define the recording source, recording schedule and recording capacity. A total of 2 recording settings can be configured.

Recording name:

Enable this recording

Priority:

Source:

**Recording Schedule**

Sun  Mon  Tue  Wed  Thu  Fri  Sat

**Time**

Always

From  to  [hh:mm]

Destination:

Capacity:

Entire free space

Limit recording size in  Mbytes

File name prefix:

Enable cyclic recording

Reserved amount:  Mbytes

Note: To enable recording notification please configure [Application](#) first

**Recording name:** Enter a name for the recording setting.

**Enable this recording:** Select this option to enable video recording.

**Priority:** Select the relative importance of the recording setting (High, Normal, and Low).

Source: Select the recording source (stream 1 or stream 2).

Recording Schedule: Specify the recording duration.

- Select the days of the week.
- Select the recording start and end times in 24-hr time format.

Destination: You can select the network storage to store the recorded video files.

Capacity: You can choose either the “entire free space available” or “limit the recording size”. The recording size limit must be larger than the reserved amount for cyclic recording.

File name prefix: Enter the text that will be appended to the front of the file name.

Enable cyclic recording: If you check this item, when the maximum capacity is reached, the oldest file will be overwritten by the latest one. The reserved amount is reserved for cyclic recording to prevent malfunction. This value must be larger than 15 MBytes.

If you want to enable recording notification, please click [Application](#) to set up. Please refer to **Trigger > Recording notify** on page 58 for detailed information.

When completed, select **Enable this recording**. Click **Save** to enable the setting and click **Close** to exit this page. When the system begins recording, it will send the recorded files to the Network Storage. The new recording name will appear in the drop-down list on the recording page as shown below.

To remove a recording setting from the list, select a recording name from the drop-down list and click **Delete**.

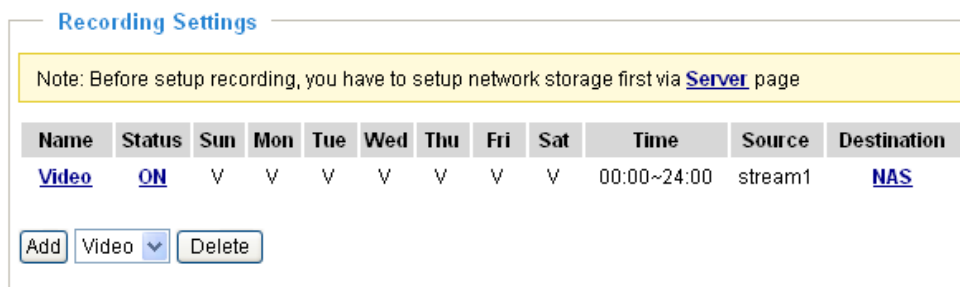

- Click [Video \(Name\)](#): Opens the Recording Settings page to modify.
- Click [ON \(Status\)](#): The Status will become [OFF](#) and stop recording.
- Click [NAS \(Destination\)](#): Opens the file list of recordings as shown below. For more information about folder naming rule, please refer to page 67 for details.

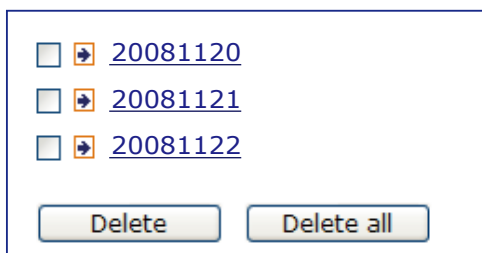

## System Log Advanced Mode

This section explains how to configure the Network Camera to send the system log to the remote server as backup.

### Remote Log

**Remote Log**

Enable remote log

**Log server settings**

IP address:

port:

You can configure the Network Camera to send the system log file to a remote server as a log backup. Before utilizing this feature, it is suggested that the user install a log-recording tool to receive system log messages from the Network Camera. An example is Kiwi Syslog Daemon. Visit <http://www.kiwisyslog.com/kiwi-syslog-daemon-overview/>.

Date	Time	Priority	Hostname	Message
01-12-2008	15:21:32	User.Info	192.168.5.121	[RTSP SERVER]: Stop one session, IP=192.168.5.122
01-12-2008	15:21:31	User.Info	192.168.5.121	[RTSP SERVER]: Start one session, IP=192.168.5.122
01-12-2008	15:20:47	Syslog.Info	192.168.5.121	syslogd 1.4.1: restart.

Follow the steps below to set up the remote log:

1. In the IP address text box, enter the IP address of the remote server.
2. In the port text box, enter the port number of the remote server.
3. When completed, select **Enable remote log** and click **Save** to enable the setting.

### Current Log

**Current Log**

```
Dec 24 17:26:02 syslogd 1.5.0: restart.
Dec 24 17:26:04 [swatchdog][100]: Ready to watch httpd.
Dec 24 17:26:05 [EVENT MGR]: Starting eventmgr with support for EcTun
Dec 24 17:26:07 [DRM Service]: Starting DRM service.
Dec 24 17:26:15 [RTSP SERVER]: XMLSParser: open failed^M
Dec 24 17:26:17 [IR Cut Control]: Day mode
Dec 24 17:26:19 [SYS]: Serial number = 0002D1733012
Dec 24 17:26:19 [SYS]: System starts at Wed Dec 24 17:26:19 UTC 2008
Dec 24 17:26:19 [NET]: === NET INFO ===
Dec 24 17:26:19 [NET]: Host IP = 192.168.5.105
Dec 24 17:26:19 [NET]: Subnet Mask = 255.255.255.0
Dec 24 17:26:19 [NET]: Gateway = 192.168.5.1
Dec 24 17:26:19 [NET]: Primary DNS = 192.168.0.10
Dec 24 17:26:19 [NET]: Secondary DNS = 192.168.0.20
Dec 24 17:26:20 [IR Cut Control]: Day mode
Dec 24 17:26:20 [SYS]: Recording entry 0 stop
```

This column displays the system log in chronological order. The system log is stored in the Network Camera's buffer area and will be overwritten when reaching a maximum limit.



## View Parameters Advanced Mode

The View Parameters page lists the entire system's parameters in alphabetical order. If you need technical assistance, please provide the information listed on this page.

[Parameter List](#)

```
system_hostname='Network Camera'  
system_ledoff='0'  
system_lowlight='1'  
system_date='2008/12/25'  
system_time='10:16:25'  
system_datetime=''  
system_ntp=''  
system_timezoneindex='320'  
system_daylight_enable='0'  
system_daylight_dstactualmode='1'  
system_daylight_auto_begintime='NONE'  
system_daylight_auto_endtime='NONE'  
system_daylight_timezones=',-360,-320,-280,-240,-241,-200,-201,-1'  
system_privacy='0'  
system_updateinterval='0'  
system_info_modelname='IP7330'  
system_info_extendedmodelname=''  
system_info_serialnumber='0002D1733012'  
system_info_firmwareversion='IP7330-VVTK-0100a'  
system_info_language_count='9'  
system_info_language_i0='English'  
system_info_language_i1='Deutsch'  
system_info_language_i2='Español'  
system_info_language_i3='Français'  
system_info_language_i4='Italiano'  
system_info_language_i5='日本語'  
system_info_language_i6='Português'  
system_info_language_i7='简体中文'  
system_info_language_i8='繁體中文'  
system_info_language_i9=''  
system_info_language_i10=''  
system_info_language_i11=''  
system_info_language_i12=''  
system_info_language_i13=''  
system_info_language_i14=''  
system_info_language_i15=''
```

## Maintenance

This chapter explains how to restore the Network Camera to factory default, upgrade firmware version, etc.

### Reboot

**Reboot**

Reboot the device

This feature allows you to reboot the Network Camera, which takes about one minute to complete. When completed, the live video page will be displayed in your browser. The following message will be displayed during the rebooting process.

The device is rebooting now. Your browser will reconnect to <http://192.168.5.151:80/>  
If the connection fails, please manually enter the above IP address in your browser.

|||||||

If the connection fails after rebooting, manually enter the IP address of the Network Camera in the address field to resume the connection.

### Restore

**Restore**

Restore all settings to factory default except settings in

Network Type  
  Daylight Saving Time  
  Custom language

This feature allows you to restore the Network Camera to factory default settings.

Network Type: Select this option to retain the Network Type settings. (Please refer to Network Type on page 30.)

Daylight Saving Time: Select this option to retain the Daylight Saving Time settings. (Please refer to System on page 22.)

Custom Language: Select this option to retain the Custom Language settings.

If none of the options is selected, all settings will be restored to factory default. The following message is displayed during the restoring process.

The device is rebooting now. Your browser will reconnect to <http://192.168.5.151:80/>  
If the connection fails, please manually enter the above IP address in your browser.

|||||||

## Export / Upload Files Advanced Mode

This feature allows you to Export / Upload daylight saving time rules, custom language files, and setting backup files.

**Export files**

Export daylight saving time configuration file	<input type="button" value="Export"/>
Export language file	<input type="button" value="Export"/>
Export setting backup file	<input type="button" value="Export"/>

**Upload files**

Update daylight saving time rules	<input type="text"/>	<input type="button" value="Browse..."/>	<input type="button" value="Upload"/>
Update custom language file	<input type="text"/>	<input type="button" value="Browse..."/>	<input type="button" value="Upload"/>
Upload setting backup file	<input type="text"/>	<input type="button" value="Browse..."/>	<input type="button" value="Upload"/>

Export daylight saving time configuration file: Click to set the start and end time of DST.

Follow the steps below to export:

1. In the Export files column, click **Export** to export the daylight saving time configuration file from the Network Camera.
2. A file download dialog will pop up as shown below. Click **Open** to review the XML file or click **Save** to store the file for editing.

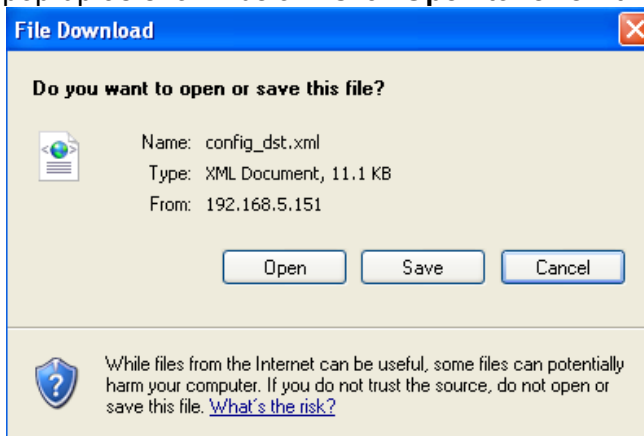

3. Open the file with Microsoft® Notepad and locate your time zone; set the start and end time of DST. When completed, save the file.

In the example below, DST begins each year at 2:00 a.m. on the second Sunday in March and ends at 2:00 a.m. on the first Sunday in November.

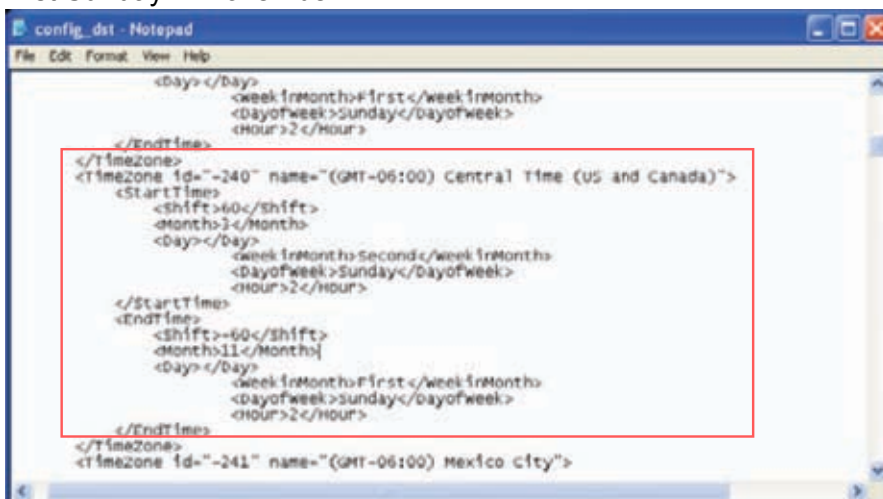

Upload daylight saving time rule: Click **Browse...** and specify the XML file to upload.

If the incorrect date and time are assigned, you will see the following warning message when uploading the file to the Network Camera.

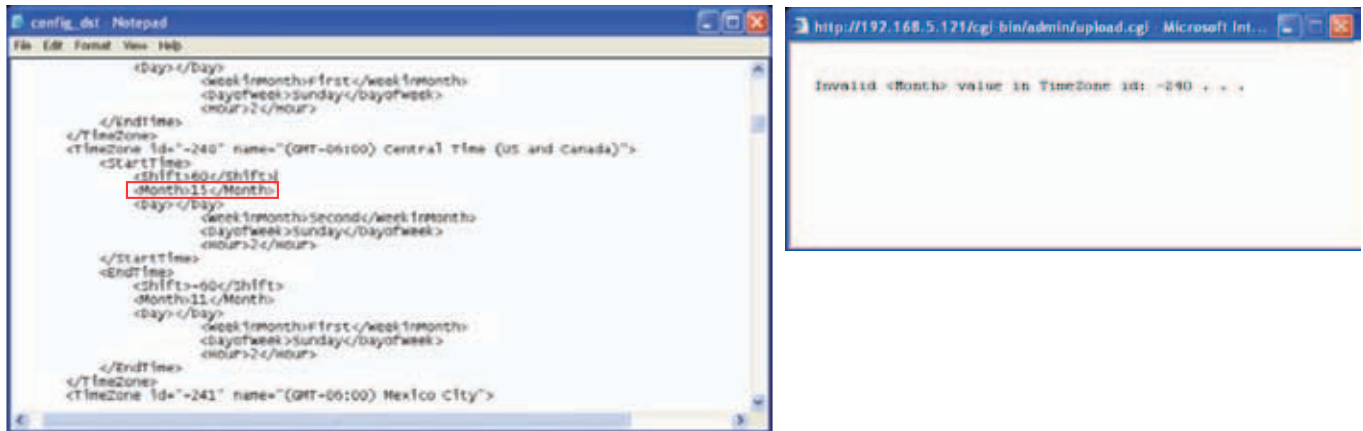

The following message is displayed when attempting to upload an incorrect file format.

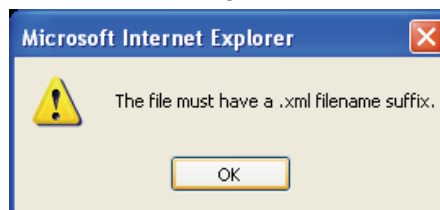

Export language file: Click to export language strings. VIVOTEK provides nine languages: English, Deutsch, Español, Français, Italiano, 日本語, Português, 簡體中文, and 繁體中文.

Upload custom language file: Click **Browse...** and specify your own custom language file to upload.

Export setting backup file: Click to export all parameters for the device and user-defined scripts.

Upload setting backup file: Click **Browse...** to upload a setting backup file. Please note that the model and firmware version of the device should be the same as the setting backup file. If you have set up a fixed IP or other special settings for your device, it is not suggested to upload a settings backup file.

## Upgrade Firmware

**Upgrade firmware**

Select firmware file

This feature allows you to upgrade the firmware of your Network Camera. It takes a few minutes to complete the process.

Note: Do not power off the Network Camera during the upgrade!

Follow the steps below to upgrade the firmware:

1. Download the latest firmware file from the VIVOTEK website. The file is in .pkg file format.
2. Click **Browse...** and specify the firmware file.
3. Click **Upgrade**. The Network Camera starts to upgrade and will reboot automatically when the upgrade completes.

If the upgrade is successful, you will see "Reboot system now!! This connection will close". After that, re-access the Network Camera.

The following message is displayed when the upgrade has succeeded.

Reboot system now!!  
This connection will close.

The following message is displayed when you have selected an incorrect firmware file.

Starting firmware upgrade..  
Do not power down the server during the upgrade.  
The server will restart automatically after the upgrade is completed.  
It will takes about 1 - 5 minutes.  
Wrong PKG file format  
Unpack fail

# Appendix

## URL Commands for the Network Camera

### Overview

For some customers who already have their own web site or web control application, the Network Camera/Video Server can be easily integrated through URL syntax. This section specifies the external HTTP-based application programming interface. The HTTP-based camera interface provides the functionality to request a single image, control camera functions (PTZ, output relay etc.), and get and set internal parameter values. The image and CGI-requests are handled by the built-in Web server.

### Style Convention

In URL syntax and in descriptions of CGI parameters, text within angle brackets denotes content that is to be replaced with either a value or a string. When replacing the text string, the angle brackets should also be replaced. An example of this is the description of the name for the server, denoted with `<servername>` in the URL syntax description below, that is replaced with the string `myserver` in the URL syntax example further down in the page.

URL syntax is denoted with the word "Syntax:" written in bold face followed by a box with the referenced syntax as shown below. For example, name of the server is written as `<servername>` and is intended to be replaced with the name of the actual server. This can either be a name, e.g., "mywebcam" or "thecam.adomain.net" or the associated IP number for the server, e.g., 192.168.0.220.

**Syntax:**

```
http://<servername>/cgi-bin/viewer/video.jpg
```

Description of returned data is written with "**Return:**" in bold face followed by the returned data in a box. All data returned as HTTP formatted, i.e., starting with the string HTTP is line separated with a Carriage Return and Line Feed (CRLF) printed as `\r\n`.

**Return:**

```
HTTP/1.0 <HTTP code> <HTTP text>\r\n
```

URL syntax examples are written with "**Example:**" in bold face followed by a short description and a light grey box with the example.

**Example:** request a single snapshot image

```
http://mywebserver/cgi-bin/viewer/video.jpg
```

## General CGI URL syntax and parameters

CGI parameters are written in lower-case and as one word without any underscores or other separators. When the CGI request includes internal camera parameters, the internal parameters must be written exactly as they are named in the camera or video server. The CGIs are organized in function related directories under the cgi-bin directory. The file extension of the CGI is required.

Syntax:

```
http://<servername>/cgi-bin/<subdir>[/<subdir>...]/<cgi>.<ext>
[?<parameter>=<value>[&<parameter>=<value>...]]
```

**Example:** Setting digital output #1 to active

<http://mywebserver/cgi-bin/dido/setdo.cgi?do1=1>

## Security level

SECURITY LEVEL	SUB-DIRECTORY	DESCRIPTION
0	anonymous	Unprotected.
1 [view]	anonymous, viewer	1. Can view, listen, talk to camera 2. Can control dido, ptz of camera
4 [operator]	anonymous, viewer, operator	Operator's access right can modify most of camera's parameters except some privilege and network options
6 [admin]	anonymous, viewer, operator, admin	Administrator's access right can fully control the camera's operation.
7	N/A	Internal parameters. Unable to be changed by any external interface.

## Get server parameter values

**Note:** The access right depends on the URL directory.

**Method:** GET/POST

Syntax:

```
http://<servername>/cgi-bin/<anonymous>/getparam.cgi?[<parameter>]
[&<parameter>...]
```

```

http://<servername>/cgi-bin/viewer/getparam.cgi?[<parameter>]
[&<parameter>...]

http://<servername>/cgi-bin/operator/getparam.cgi?[<parameter>]
[&<parameter>...]

http://<servername>/cgi-bin/admin/getparam.cgi?[<parameter>]
[&<parameter>...]

```

where the *<parameter>* should be *<group>[\_<name>]* or *<group>[.<name>]* If you do not specify the any parameters, all the parameters on the server will be returned. If you specify only *<group>*, the parameters of related group will be returned.

When query parameter values, the current parameter value are returned.

Successful control request returns paramter pairs as follows.

Return:

```

HTTP/1.0 200 OK\r\n
Content-Type: text/html\r\n
Context-Length: <length>\r\n
\r\n
<parameter pair>

```

where *<parameter pair>* is

```

<parameter>=<value>\r\n
[<parameter pair>]

```

*<length>* is the actual length of content.

**Example:** request IP address and it's response

Request:

```
http://192.168.0.123/cgi-bin/admin/getparam.cgi?network_ipaddress
```

Response:

```

HTTP/1.0 200 OK\r\n
Content-Type: text/html\r\n
Context-Length: 33\r\n
\r\n
network.ipaddress=192.168.0.123\r\n

```



## Set server parameter values

**Note:** The access right depends on the URL directory.

**Method:** GET/POST

Syntax:

```
http://<servername>/cgi-bin/<anonymous>/setparam.cgi? <parameter>=<value>
[&<parameter>=<value>...][&update=<value>][&return=<return page>]

http://<servername>/cgi-bin/<viewer>/setparam.cgi? <parameter>=<value>
[&<parameter>=<value>...][&update=<value>] [&return=<return page>]

http://<servername>/cgi-bin/<operator>/setparam.cgi? <parameter>=<value>
[&<parameter>=<value>...][&update=<value>] [&return=<return page>]

http://<servername>/cgi-bin/<admin>/setparam.cgi? <parameter>=<value>
[&<parameter>=<value>...][&update=<value>] [&return=<return page>]
```

PARAMETER	VALUE	DESCRIPTION
<b>&lt;group&gt;_&lt;name&gt;</b>	value to assigned	Assign <value> to the parameter <group>_<name>
<b>update</b>	<boolean>	set to 1 to actually update all fields (no need to use update parameter in each group)
<b>return</b>	<return page>	Redirect to the page <return page> after the parameter is assigned. The <return page> can be a full URL path or relative path according the the current path. If you omit this parameter, it will redirect to an empty page.  (note: The return page can be a general HTML file(.htm, .html) or a Vivotek server script executable (.vspx) file. It can not be a CGI command. It can not have any extra parameters. This parameter must be put at end of parameter list)

Return:

```
HTTP/1.0 200 OK\r\n
Content-Type: text/html\r\n
Context-Length: <length>\r\n
\r\n
<parameter pair>
```

where <parameter pair> is

<parameter>=<value>\r\n

[<parameter pair>]

Only the parameters that you set and readable will be returned.

**Example:** Set the IP address of server to 192.168.0.123

Request:

[http://myserver/cgi-bin/admin/setparam.cgi?network\\_ipaddress=192.168.0.123](http://myserver/cgi-bin/admin/setparam.cgi?network_ipaddress=192.168.0.123)

Response:

HTTP/1.0 200 OK\r\n

Content-Type: text/html\r\n

Content-Length: 33\r\n

\r\n

network.ipaddress=192.168.0.123\r\n

## Available parameters on the server

Valid values:

VALID VALUES	DESCRIPTION
string[<n>]	Text string shorter than 'n' characters. The characters ";',>,& are invalid.
password[<n>]	The same as string but display '*' instead
integer	Any number between $(-2^{31} - 1)$ and $(2^{31} - 1)$
positive integer	Any number between 0 and $(2^{32} - 1)$
<m> ~ <n>	Any number between 'm' and 'n'
domain name[<n>]	A string limited to contain a domain name shorter than 'n' characters (eg. www.ibm.com)
email address [ <n> ]	A string limited to contain a email address shorter than 'n' characters (eg. joe@www.ibm.com)
ip address	A string limited to contain an ip address (eg. 192.168.1.1)
mac address	A string limited to contain mac address without hyphen or colon connected
boolean	A boolean value 1 or 0 represents [Yes or No], [True or False], [Enable or Disable].
<value1>, <value2>, <value3>, ...	Enumeration. Only given values are valid.
blank	A blank string
everything inside <>	As description

NOTE: The camera should prevent to restart when parameter changed.

Group: **system**

NAME	VALUE	SECURITY (get/set)	DESCRIPTION
hostname	string[40]	1/6	host name of server (Network Camera, Wireless Network Camera, Video Server, Wireless Video Server)
lowlight	<boolean>	6/6	(0) Turn on white light LED in all condition (1) Only turn on white light LED in low light condition (product dependent)
date	<yyyy/mm/dd>, keep, auto	6/6	Current date of system. Set to 'keep' keeping date unchanged. Set to 'auto' to use NTP to synchronize date.
time	<hh:mm:ss>, keep, auto	6/6	Current time of system. Set to 'keep' keeping time unchanged. Set to 'auto' to use NTP to synchronize time.
datetime	<MMDDhhmmYYYY.ss>	6/6	Another current time format of system.
ntp	<domain name>, <ip address>, <blank>	6/6	NTP server *do not use "skip to invoke default server" for default
timezoneindex	-489 ~ 529	6/6	Indicate timezone and area -480: GMT-12:00 Eniwetok, Kwajalein -440: GMT-11:00 Midway Island, Samoa -400: GMT-10:00 Hawaii -360: GMT-09:00 Alaska -320: GMT-08:00 Las Vegas, San_Francisco, Vancouver -280: GMT-07:00 Mountain Time, Denver -281: GMT-07:00 Arizona -240: GMT-06:00 Central America, Central Time, Mexico City, Saskatchewan -200: GMT-05:00 Eastern Time, New York, Toronto -201: GMT-05:00 Bogota, Lima, Quito, Indiana -180: GMT-04:30 Caracas

			<p>-160: GMT-04:00 Atlantic Time, Canada, La Paz, Santiago</p> <p>-140: GMT-03:30 Newfoundland</p> <p>-120: GMT-03:00 Brasilia, Buenos Aires, Georgetown, Greenland</p> <p>-80: GMT-02:00 Mid-Atlantic</p> <p>-40: GMT-01:00 Azores, Cape_Verde_IS.</p> <p>0: GMT Casablanca, Greenwich Mean Time: Dublin, Edinburgh, Lisbon, London</p> <p>40: GMT 01:00 Amsterdam, Berlin, Rome, Stockholm, Vienna, Madrid, Paris</p> <p>41: GMT 01:00 Warsaw, Budapest, Bern</p> <p>80: GMT 02:00 Athens, Helsinki, Istanbul, Riga</p> <p>81: GMT 02:00 Cairo</p> <p>82: GMT 02:00 Lebanon, Minsk</p> <p>83: GMT 02:00 Israel</p> <p>120: GMT 03:00 Baghdad, Kuwait, Riyadh, Moscow, St. Petersburg, Nairobi</p> <p>121: GMT 03:00 Iraq</p> <p>140: GMT 03:30 Tehran</p> <p>160: GMT 04:00 Abu Dhabi, Muscat, Baku, Tbilisi, Yerevan</p> <p>180: GMT 04:30 Kabul</p> <p>200: GMT 05:00 Ekaterinburg, Islamabad, Karachi, Tashkent</p> <p>220: GMT 05:30 Calcutta, Chennai, Mumbai, New Delhi</p> <p>230: GMT 05:45 Kathmandu</p> <p>240: GMT 06:00 Almaty, Novosibirsk, Astana, Dhaka, Sri Jayawardenepura</p> <p>260: GMT 06:30 Rangoon</p> <p>280: GMT 07:00 Bangkok, Hanoi, Jakarta, Krasnoyarsk</p> <p>320: GMT 08:00 Beijing, Chongqing, Hong Kong, Kuala Lumpur, Singapore, Taipei</p> <p>360: GMT 09:00 Osaka, Sapporo, Tokyo, Seoul, Yakutsk</p>
--	--	--	---

			380: GMT 09:30 Adelaide, Darwin 400: GMT 10:00 Brisbane, Canberra, Melbourne, Sydney, Guam, Vladivostok 440: GMT 11:00 Magadan, Solomon Is., New Caledonia 480: GMT 12:00 Aucklan, Wellington, Fiji, Kamchatka, Marshall Is. 520: GMT 13:00 Nuku'Alofa
daylight_enable	<boolean>	6/6	enable <b>automatic</b> daylight saving to time zone
daylight_dstactual mode	<boolean>	6/7	check if current time is under daylight saving time.
daylight_auto_begin time	string[19]	6/7	display the current daylight saving begin time. (product dependent)
daylight_auto_end time	string[19]	6/7	display the current daylight saving end time. (product dependent)
updateinterval	0, 3600, 86400, 604800, 2592000	6/6	0 to Disable automatic time adjustment, otherwise, it means the seconds between NTP automatic update interval.
restore	0, <positive integer>	7/6	Restore the system parameters to default value after <value> seconds.
reset	0, <positive integer>	7/6	Restart the server after <value> seconds if <value> is non-negative.
restoreexceptnet	<Any value>	7/6	Restore the system parameters to default value except (ipaddress, subnet, router, dns1, dns2, pppoe).  This command can cooperate with other "restoreexceptXYZ" commands. When cooperating with others, the system parameters will be restored to default value except a union of combined results.
restoreexceptdst	<Any value>	7/6	Restore the system parameters to default value except all daylight saving time settings.

			This command can cooperate with other "restoreexceptXYZ" commands. When cooperating with others, the system parameters will be restored to default value except a union of combined results.
restoreexceptlang	<Any Value>	7/6	Restore the system parameters to default value except custom language file user uploaded.  This command can cooperate with other "restoreexceptXYZ" commands. When cooperating with others, the system parameters will be restored to default value except a union of combined results.

SubGroup of **system: info** (The fields in this group are unchangeable.)

NAME	VALUE	SECURITY (get/set)	DESCRIPTION
modelname	string[40]	0/7	Internal model name of server (eg. IP7139)
serialnumber	<mac address>	0/7	12 characters mac address without hyphen connected
firmwareversion	string[40]	0/7	The version of firmware, including model, company, and version number in the format <MODEL-BRAND-VERSION>
language_count	<integer>	0/7	number of webpage language available on the server
language_i<0~(count-1)>	string[16]	0/7	Available language lists
customlanguage_maxcount	<integer>	0/7	Maximum number of custom language supported on the server
customlanguage_count	<integer>	0/7	Number of custom language which has been uploaded to the server
customlanguage_j<0~(maxcount-1)>	string	0/7	Custom language name

Group: **status**

NAME	VALUE	SECURITY (get/set)	DESCRIPTION
di_i<0~(ndi-1)>	<boolean>	1/7	0 => Inactive, normal 1 => Active, triggered
do_i<0~ndi-1)>	<boolean>	1/7	0 => Inactive, normal

			1 => Active, triggered
daynight	day, night	7/7	The day/night status judge by light sensor
onlinenum_rtsp	integer	6/7	current RTSP connection numbers
onlinenum_httppush	integer	6/7	current HTTP push server connection numbers

Group: **di\_i<0~(ndi-1)>** (*capability.ndi > 0*)

NAME	VALUE	SECURITY (get/set)	DESCRIPTION
normalstate	high, low	1/1	indicate whether open circuit or closed circuit represents inactive status

Group: **do\_i<0~(ndo-1)>** (*capability.ndo > 0*)

NAME	VALUE	SECURITY (get/set)	DESCRIPTION
normalstate	open, grounded	1/1	indicate whether open circuit or closed circuit represents inactive status

Group: **security**

NAME	VALUE	SECURITY (get/set)	DESCRIPTION
user_i0_name	string[64]	6/7	User's name of root
user_i<1~20>_name	string[64]	6/7	User's name
user_i0_pass	password[64]	6/6	root's password
user_i<1~20>_pass	password[64]	7/6	User's password
user_i0_privilege	viewer, operator, admin	6/7	root's privilege
user_i<1~20>_privilege	viewer, operator, admin	6/6	User's privilege.

Group: **network**

NAME	VALUE	SECURITY (get/set)	DESCRIPTION
type	lan, pppoe	6/6	Network connection type
resetip	<boolean>	6/6	1 => get ipaddress, subnet, router, dns1, dns2 from

			DHCP server at next reboot 0 => use preset ipaddress, subnet, router, dns1, and dns2
ipaddress	<ip address>	6/6	IP address of server
subnet	<ip address>	6/6	subnet mask
router	<ip address>	6/6	default gateway
dns1	<ip address>	6/6	primary DNS server
dns2	<ip address>	6/6	secondary DNS server
wins1	<ip address>	6/6	primary WINS server
wins2	<ip address>	6/6	secondary WINS server

Subgroup of **network: ftp**

NAME	VALUE	SECURITY (get/set)	DESCRIPTION
port	21, 1025~65535	6/6	local ftp server port

Subgroup of **network: http**

NAME	VALUE	SECURITY (get/set)	DESCRIPTION
port	80, 1025 ~ 65535	6/6	HTTP port
alternateport	1025~65535	6/6	Alternative HTTP port
authmode	basic, digest	1/6	HTTP authentication mode
s0_accessname	string[32]	1/6	Http server push access name for stream 1 (capability.protocol.spush_mjpeg =1 and video.stream.count>0)
s1_accessname	string[32]	1/6	Http server push access name for stream 2 (capability.protocol.spush_mjpeg =1 and video.stream.count>1)
anonymousviewing	<boolean>	1/6	Enable anoymous streaming viewing.

Subgroup of **network: https**

NAME	VALUE	SECURITY (get/set)	DESCRIPTION
port	443, 1025 ~ 65535	6/6	HTTPS port

Subgroup of **network: rtsp**



NAME	VALUE	SECURITY (get/set)	DESCRIPTION
port	554, 1025 ~ 65535	1/6	RTSP port (capability.protocol.rtsp=1)
anonymousviewing	<boolean>	1/6	Enable anonymous streaming viewing.
authmode	disable, basic, digest	1/6	RTSP authentication mode (capability.protocol.rtsp=1)
s0_accessname	string[3b;42]	1/6	RTSP access name for stream1 (capability.protocol.rtsp=1 and video.stream.count>0)
s1_accessname	string[32]	1/6	RTSP access name for stream2 (capability.protocol.rtsp=1 and video.stream.count>1)

Subgroup of **rtsp\_s<0~(n-1)>**: **multicast**, n is stream count (capability.protocol.rtp.multicast=1)

NAME	VALUE	SECURITY (get/set)	DESCRIPTION
alwaysmulticast	<boolean>	4/4	Enable always multicast
ipaddress	<ip address>	4/4	Multicast IP address
videoport	1025 ~ 65535	4/4	Multicast video port
ttl	1 ~ 255	4/4	Multicast time to live value

Subgroup of **network**: **rtp**

NAME	VALUE	SECURITY (get/set)	DESCRIPTION
videoport	1025 ~ 65535	6/6	video channel port for RTP (capability.protocol.rtp_unicast=1)

Subgroup of **network**: **pppoe**

NAME	VALUE	SECURITY (get/set)	DESCRIPTION
user	string[128]	6/6	PPPoE account user name

pass	password[64]	6/6	PPPoE account password
------	--------------	-----	------------------------

Group: **ipfilter**

NAME	VALUE	SECURITY (get/set)	DESCRIPTION
enable	<boolean>	6/6	Enable or disable ipfilter settings
admin_enable	<boolean>	6/6	Enable or disable the function always allow the admin IP address to access this device
admin_ip	1.0.0.0 ~ 255.255.255.255	6/6	Always allow this IP connect to camera when admin_enable=1
maxconnection	0~10	6/6	Maximum number of concurrent streaming connection(s) limit
allow_i<0~9>_start	1.0.0.0 ~ 255.255.255.255	6/6	Allowed starting IP address for RTSP connection
allow_i<0~9>_end	1.0.0.0 ~ 255.255.255.255	6/6	Allowed ending IP address for RTSP connection
deny_i<0~9>_start	1.0.0.0 ~ 255.255.255.255	6/6	Denied starting IP address for RTSP connection
deny_i<0~9>_end	1.0.0.0 ~ 255.255.255.255	6/6	Denied ending IP address for RTSP connection

Group: **videoin**

NAME	VALUE	SECURITY (get/set)	DESCRIPTION
cmosfreq	50, 60	4/4	CMOS frequency (videoin.type=2) (product dependent)
whitebalance	auto, manual	4/4	auto, auto white balance manual indoor, 3200K fluorescent, 5500K outdoor, > 5500K
atwbvalue	0 ~ 65535	4/4	The auto white balance value.

Group: **videoin\_c<0~(n-1)>** for n channel products, m is stream number

NAME	VALUE	SECURITY (get/set)	DESCRIPTION
color	0, 1	4/4	0 => monochrome

			1 => color
flip	<boolean>	4/4	flip the image
mirror	<boolean>	4/4	mirror the image
text	string[16]	1/4	enclosed caption
imprinttimestamp	<boolean>	4/4	Overlay time stamp on video
maxexposure	1~30	4/4	Maximum exposure time
scenemode	0, 1	4/4	0 => outdoor mode 1 => indoor mode
s<0~(m-1)>_codectype	mpeg4, mjpeg	4/4	video codec type
s<0~(m-1)>_resolution	VGA CMOS => 176x144, 320x240, 640x480	4/4	Video resolution in pixel
s<0~(m-1)>_mpeg4_intrap eriod	250, 500, 1000, 2000, 3000, 4000	4/4	The period of intra frame in milliseconds
s<0~(m-1)>_mpeg4_rateco ntrolmode	cbr, vbr	4/4	cbr, constant bitrate vbr, fix quality
s<0~(m-1)>_mpeg4_quant	0, 1~5	4/4	quality of video when choosing vbr in "ratecontrolmode". 0 is customized manual input setting. 1 is worst quality and 5 is the best quality.
s<0~(m-1)>_mpeg4_qvalue	1~31	7/4	The specific quality parameter of mpeg4 encoder. 1 is best quality and 31 is the worst quality.
s<0~(m-1)>_mpeg4_bitrate	1000~4000000	4/4	Set bit rate in bps when choose cbr in "ratecontrolmode"
s<0~(m-1)>_mpeg4_maxfr ame	1~25, 26~30 (only for NTSC or 60Hz CMOS)	4/4	set maximum frame rate in fps (for MPEG-4)
s<0~(m-1)>_mjpeg_quant	0 ~ 5	4/4	quality of jpeg video. 0 is customized manual input setting. 1 is worst quality and 5 is the best quality.
s<0~(m-1)>_mjpeg_qvalue	10~200	7/4	The specific quality parameter of jpeg

			encoder. 10 is best quality and 200 is the worst quality.
s<0~(m-1)>_mjpeg_maxframe	1~25, 26~30 (only for 60Hz CMOS)	4/4	set maximum frame rate in fps (for JPEG)
s<0~(m-1)>_forcei	1	7/6	Force I frame

Group: **image\_c<0~(n-1)>** for n channel products

NAME	VALUE	SECURITY (get/set)	DESCRIPTION
brightness	-5 ~ 5	4/4	Adjust brightness of image according to mode settings.
saturation	-5 ~ 5	4/4	Adjust saturation of image according to mode settings.
contrast	-5 ~ 5	4/4	Adjust contrast of image according to mode settings.
sharpness	-3 ~ 3	4/4	Adjust sharpness of image according to mode settings.

Group: **imagepreview\_c<0~(n-1)>** for n channel products

NAME	VALUE	SECURITY (get/set)	DESCRIPTION
brightness	-5 ~ 5	4/4	Preview of adjusting brightness of image according to mode settings.
Saturation	-5 ~ 5	4/4	Preview of adjusting saturation of image according to mode settings.
Contrast	-5 ~ 5	4/4	Preview of adjusting contrast of image according to mode settings.
Sharpness	-3 ~ 3	4/4	Preview of adjusting sharpness of image according to mode settings.
videoin_whitebalance	auto, manual	4/4	Preview of adjusting white balance of image according to mode settings
videoin_restoreatwb	0, 1~	4/4	Restore of adjusting white balance of image according to mode settings

Group: **motion\_c<0~(n-1)>** for n channel product

NAME	VALUE	SECURITY (get/set)	DESCRIPTION
Enable	<boolean>	4/4	enable motion detection
win_i<0~2>_enable	<boolean>	4/4	enable motion window 1~3
win_i <0~2>_name	string[14]	4/4	name of motion window 1~3
win_i <0~2>_left	0 ~ 320	4/4	Left coordinate of window position.

win_i <0~2>_top	0 ~ 240	4/4	Top coordinate of window position.
win_i <0~2>_width	0 ~ 320	4/4	Width of motion detection window.
win_i <0~2>_height	0 ~ 240	4/4	Height of motion detection window.
win_i <0~2>_objsize	0 ~ 100	4/4	Percent of motion detection window.
win_i <0~2>_sensitivity	0 ~ 100	4/4	Sensitivity of motion detection window.

Group: **motion\_c<0~(n-1)>\_profile\_i<0~(m-1)>** for n channel, m motion profile product  
(capability\_nmotionprofile > 0)

NAME	VALUE	SECURITY (get/set)	DESCRIPTION
Enable	<boolean>	4/4	enable motion detection
Policy	day, night, schedule	4/4	When the condition match the policy, use this profile
Beginntime	hh:mm	4/4	If choose "schedule" mode as profile policy, the begin time of this profile when enabled
Endtime	hh:mm	4/4	If choose "schedule" mode as profile policy, the end time of this profile when enabled
win_i<0~2>_enable	<boolean>	4/4	enable motion window 1~3
win_i <0~2>_name	string[14]	4/4	name of motion window 1~3
win_i <0~2>_left	0 ~ 320	4/4	Left coordinate of window position.
win_i <0~2>_top	0 ~ 240	4/4	Top coordinate of window position.
win_i <0~2>_width	0 ~ 320	4/4	Width of motion detection window.
win_i <0~2>_height	0 ~ 240	4/4	Height of motion detection window.
win_i <0~2>_objsize	0 ~ 100	4/4	Percent of motion detection window.
win_i <0~2>_sensitivity	0 ~ 100	4/4	Sensitivity of motion detection window.

Group: **tampering\_c<0~(n-1)>** for n channel,

NAME	VALUE	SECURITY (get/set)	DESCRIPTION
enable	<boolean>	4/4	Enable or disable camera tampering detection
threshold	0 ~ 255	4/4	The sensitivity to judge if camera has been tampered 0: lowest sensitivity 255: highest sensitivity
duration	10 ~ 600	4/4	Judge camera has been tampered if exceeding this duration

Group: **ddns**

NAME	VALUE	SECURITY (get/set)	DESCRIPTION
enable	<boolean>	6/6	Enable or disable the dynamic dns.
provider	Safe100, DyndnsDynamic, DyndnsCustom, TZO, DHS, DynInterfree, CustomSafe100	6/6	Safe100 => safe100.net DyndnsDynamic => dyndns.org (dynamic) DyndnsCustom => dyndns.org (custom) TZO => tzo.com DHS => dhs.org DynInterfree => dyn-interfree.it CustomSafe100 => Custom server using safe100 method
<provider>_hostname	string[128]	6/6	Your dynamic hostname.
<provider>_usernameemail	string[64]	6/6	Your user or email to login ddns service provider
<provider>_passwordkey	string[64]	6/6	Your password or key to login ddns service provider
<provider>_server name	string[128]	6/6	The server name for safe100. (This field only exists for provider is customsaf100)

Group: **upnpresentation**

NAME	VALUE	SECURITY (get/set)	DESCRIPTION
enable	<boolean>	6/6	Enable or disable the UPNP presentation service.

Group: **upnpportforwarding**

NAME	VALUE	SECURITY (get/set)	DESCRIPTION
enable	<boolean>	6/6	Enable or disable the UPNP port forwarding service.
upnpnatstatus	0~3	6/7	The status of UpnP port forwarding, used internally. 0 is OK, 1 is FAIL, 2 is no IGD router, 3 is no need to do port forwarding

Group: **syslog**

NAME	VALUE	SECURITY	DESCRIPTION
------	-------	----------	-------------

		(get/set)	
enableremotelog	<boolean>	6/6	enable remote log
serverip	<IP address>	6/6	Log server IP address
serverport	514, 1025~65535	6/6	Server port used for log
level	0~7	6/6	The levels to distinguish the importance of information. 0: LOG_EMERG 1: LOG_ALERT 2: LOG_CRIT 3: LOG_ERR 4: LOG_WARNING 5: LOG_NOTICE 6: LOG_INFO 7: LOG_DEBUG

Group: **layout** (product dependent)

NAME	VALUE	SECURITY (get/set)	DESCRIPTION
Logo_default	<boolean>	1/6	0 => Custom logo 1 => Default logo
logo_link	string[64]	1/6	Hyperlink of the logo
theme_option	1~4	1/6	1~3: One of the default themes 4: Custom definition
theme_color_font	string[7]	1/6	Font color
theme_color_configfont	string[7]	1/6	Font color of configuration area
theme_color_titlefont	string[7]	1/6	Font color of video title
theme_color_controlbackground	string[7]	1/6	Background color of control area
theme_color_configbackground	string[7]	1/6	Background color of configuration area
theme_color_videobackground	string[7]	1/6	Background color of video area
theme_color_case	string[7]	1/6	Frame color

Group: **privacymask\_c<0~(n-1)>** for n channel product

NAME	VALUE	SECURITY (get/set)	DESCRIPTION
------	-------	-----------------------	-------------

enable	<boolean>	4/4	Enable the privacy mask
win_i<0~4>_enable	<boolean>	4/4	Enable the privacy mask window
win_i<0~4>_name	string[14]	4/4	The name of privacy mask window
win_i<0~4>_left	0 ~ 320/352	4/4	Left coordinate of window position.
win_i<0~4>_top	0 ~ 240/288	4/4	Top coordinate of window position.
win_i<0~4>_width	0 ~ 320/352	4/4	Width of privacy mask window
win_i<0~4>_height	0 ~ 240/288	4/4	Height of privacy mask window
win_i<0~4>_color	0 ~ 13	4/4	Color of privacy mask window

Group: **capability**

NAME	VALUE	SECURITY (get/set)	DESCRIPTION
api_httpversion	0200a	0/7	The HTTP API version.
bootuptime	<positive integer>	0/7	The server bootup time
nir	0, <positive integer>	0/7	number of IR interface
npir	0, <positive integer>	0/7	number of PIR
ndi	0, <positive integer>	0/7	number of digital input
ndo	0, <positive integer>	0/7	number of digital output
naudioin	0, <positive integer>	0/7	number of audio input
naudioout	0, <positive integer>	0/7	number of audio output
nvideoin	<positive integer>	0/7	number of video input
nmediastream	<positive integer>	0/7	number of media stream per channel
nvideosetting	<positive integer>	0/7	number of video settings per channel
naudiosetting	<positive integer>	0/7	number of audio settings per channel
nuart	0, <positive integer>	0/7	number of UART interface
nmotionprofile	0,	0/7	number of motion profiles



	<positive integer>		
ptzenabled	< positive integer >	0/7	<p>An 32-bits integer, each bit can be set separately as follows:</p> <p>Bit 0 =&gt; Support camera control function 0(not support), 1(support)</p> <p>Bit 1 =&gt; Build-in or external camera. 0(external), 1(build-in)</p> <p>Bit 2 =&gt; Support pan operation. 0(not support), 1(support)</p> <p>Bit 3 =&gt; Support tilt operation. 0(not support), 1(support)</p> <p>Bit 4 =&gt; Support zoom operation. 0(not support), 1(support)</p> <p>Bit 5 =&gt; Support focus operation. 0(not support), 1(support)</p> <p>Bit 6 =&gt; Support iris operation. 0(not support), 1(support)</p> <p>Bit 7 =&gt; External or build-in PT. 0(build-in), 1(external)</p> <p>Bit 8 =&gt; Invalidate bit 1 ~ 7. 0(bit 1 ~ 7 are valid), 1(bit 1 ~ 7 are invalid)</p> <p>Bit 9 =&gt; Reserved bit; Invalidate lens_pan, Lens_tilt, lens_zoon, lens_focus, len_iris. 0(fields are valid), 1(fields are invalid)</p>
protocol_https	< boolean >	0/7	indicate whether to support http over SSL
protocol_rtsp	< boolean >	0/7	indicate whether to support rtsp
protocol_sip	<boolean>	0/7	indicate whether to support sip
protocol_maxconnection	<positive integer>	0/7	The maximum allowed simultaneous connections
protocol_maxgeneralconnection	<positive integer>	0/7	The maximum allowed general simultaneous connections
protocol_maxmegapixelconnection	<positive integer>	0/7	The maximum allowed megapixel simultaneous connections
protocol_maxrtspconnection	<positive integer>	0/7	The maximum allowed rtsp simultaneous connections

protocol_rtp_multicast_scalable	<boolean>	0/7	indicate whether to support scalable multicast
protocol_rtp_multicast_backchannel	<boolean>	0/7	indicate whether to support backchannel multicast
protocol_rtp_tcp	<boolean>	0/7	indicate whether to support rtp over tcp
protocol_rtp_http	<boolean>	0/7	indicate whether to support rtp over http
protocol_server_push_motion_jpeg	<boolean>	0/7	indicate whether to support server push motion jpeg
protocol_snmp	<boolean>	0/7	indicate whether to support snmp
videoin_type	0, 1, 2	0/7	0 => Interlaced CCD 1 => Progressive CCD 2 => CMOS
videoin_resolution	<a list of the available resolution separates by comma>	0/7	available resolutions list
videoin_maxframe_rate	<a list of the available max frame rate separates by comma>	0/7	available framerate at the videoin_resolution list index
videoin_codec	<a list of the available codec types separates by comma>	0/7	available codec list
videoout_codec	<a list of the available codec types separates by comma>	0/7	available codec list
transmission_mode	Tx, Rx, Both	0/7	Indicate what kind of transmission mode the machine used. TX: server, Rx: receiver box, Both: DVR?.
network_wire	<boolean>	0/7	Indicate whether to support the Ethernet
network_wireless	<boolean>	0/7	Indicate whether to support the wireless
derivative_brand	<boolean>	0/7	Indicate whether to support upgrade function for the derivative brand. For example, if the value is true, the VVTK product can be upgraded to VVXX. (TCVW<->TCXX is excepted)
evctrlchannel	<boolean>	0/7	Indicate whether to support the http tunnel

			for event/control transfer
joystick	<boolean>	0/7	Indicate whether to support the joystick control

Group: **event\_i<0~2>**

PARAMETER	VALUE	SECURITY (get/set)	DESCRIPTION
name	string[40]	6/6	The identification of this entry
enable	0, 1	6/6	To enable or disable this event.
priority	0, 1, 2	6/6	Indicate the priority of this event. "0" indicates low priority. "1" indicates normal priority. "2" indicates high priority.
delay	1~999	6/6	Delay seconds before detect next event.
trigger	boot, di, motion, seq, reconfirm, tampering	6/6	Indicate the trigger condition. "boot" indicates system boot. "di" indicates digital input. "motion" indicates video motion detection. "seq" indicates periodic condition. "visignal" indicates video input signal loss "reconfirm" indicates space for recording media is full "tampering" indicates camera tampering detected
di	<integer>	6/6	Indicate which di detected. This field is required when trigger condition is "di". One bit represents one digital input. The LSB indicates DI 0.
mdwin	<integer>	6/6	Indicate which motion detection windows detected. This field is required when trigger condition is "md". One bit represents one window. The LSB indicates the 1 <sup>st</sup> window. For example, to detect the 1 <sup>st</sup> and 3 <sup>rd</sup> windows, set mdwin as 5.

mdwin0	<integer>	6/6	Indicate which motion detection windows of motion profile 0 detected. This field is required when trigger condition is "md". One bit represents one window. The LSB indicates the 1 <sup>st</sup> window. For example, to detect the 1 <sup>st</sup> and 3 <sup>rd</sup> windows, set mdwin as 5.
inter	1~999	6/6	Interval of period snapshot in minute. This field is used when trigger condition is "seq".
weekday	<interger>	6/6	Indicate which weekday is scheduled. One bit represents one weekday. The bit0 (LSB) indicates Saturday. The bit1 indicates Friday. The bit2 indicates Thursday. The bit3 indicates Wednesday. The bit4 indicates Tuesday. The bit5 indicates Monday. The bit6 indicates Sunday. For example, to detect events on Friday and Sunday, set weekday as 66.
begintime	hh:mm	6/6	Begin time of weekly schedule.
endtime	hh:mm	6/6	End time of weekly schedule. (00:00 ~ 24:00 means always.)
lowlightcondition	0, 1	6/6	Turn on IR led in some condition: 0: all conditions 1: low light condition
action_do_i<0~(ndo-1)>_enable	0, 1	6/6	To enable or disable trigger digital output.
action_do_i<0~(ndo-1)>_duration	1~999	6/6	The duration of digital output is triggered in seconds.
action_server_i<0~4>_enable	0, 1	6/6	To enable or disable this server action. The default value is 0.
action_server_i<0~4>_media	NULL, 0~4	6/6	The index of attached media.
action_server_i<0~4>_datefolder	<boolean>	6/6	Enable or disable create folders by date time and hour automatically

Group: **server\_i<0~4>**

PARAMETER	VALUE	SECURITY (get/set)	DESCRIPTION
name	string[40]	6/6	The identification of this entry
type	email, ftp, http, ns	6/6	Indicate the server type. "email" is email server. "ftp" is ftp server. "http" is http server. "ns" is network storage.
http_url	string[128]	6/6	The url of http server to upload.
http_username	string[64]	6/6	The username to login in the server.
http_passwd	string[64]	6/6	The password of the user.
ftp_address	string[128]	6/6	The ftp server address
ftp_username	string[64]	6/6	The username to login in the server.
ftp_passwd	string[64]	6/6	The password of the user.
ftp_port	0~65535	6/6	The port to connect the server.
ftp_location	string[128]	6/6	The location to upload or store the media.
ftp_passive	0, 1	6/6	To enable or disable the passive mode. 0 is to disable the passive mode. 1 is to enable the passive mode.
email_address	string[128]	6/6	The email server address
email_sslmode	<boolean>	6/6	To enable or disable the SSL mode 0 is to disable the SSL mode 1 is to enable the SSL mode
email_username	string[64]	6/6	The username to login in the server.
email_httpsmode	0, 1	6/6	Enable support SSL
email_port	0~65535	6/6	The port to connect the server.
email_passwd	string[64]	6/6	The password of the user.
email_senderemail	string[128]	6/6	The email address of sender.
email_recipientemail	string[128]	6/6	The email address of recipient.
ns_location	string[128]	6/6	The location to upload or store the media.
ns_username	string[64]	6/6	The username to login in the server.
ns_passwd	string[64]	6/6	The password of the user.
ns_workgroup	string[64]	6/6	The workgroup for network storage.

Group: **media\_i<0~4>**(media\_freespace is used internally.)

PARAMETER	VALUE	SECURITY (get/set)	DESCRIPTION
name	string[40]	6/6	The identification of this entry
type	snapshot, systemlog videoclip	6/6	The media type to send to the server or store by the server.
snapshot_source	<integer>	6/6	Indicate the source of media stream. 0 means the first stream. 1 means the second stream and etc.
snapshot_prefix	string[16]	6/6	Indicate the prefix of the filename.
snapshot_datesuffix	0, 1	6/6	To add date and time suffix to filename or not. 1 means to add date and time suffix. 0 means not to add it.
snapshot_preevent	0 ~ 7	6/6	It indicates the number of pre-event images.
snapshot_postevent	0 ~ 7	6/6	The number of post-event images.
videoclip_source	<integer>	6/6	Indicate the source of media stream. 0 means the first stream. 1 means the second stream and etc.
videoclip_prefix	string[16]	6/6	Indicate the prefix of the filename.
videoclip_preevent	0 ~ 9	6/6	It indicates the time of pre-event recording in seconds.
videoclip_maxduration	1 ~ 10	6/6	The time of maximum duration of one video clip in seconds.
videoclip_maxsize	50 ~ 600	6/6	The maximum size of one video clip file in Kbytes.

Group: **recording\_i<0~1>**

PARAMETER	VALUE	SECURITY (get/set)	DESCRIPTION
name	string[40]	6/6	The identification of this entry
enable	0, 1	6/6	To enable or disable this recoding.
priority	0, 1, 2	6/6	Indicate the priority of this recoding. "0" indicates low priority. "1" indicates normal priority. "2" indicates high priority.

source	<integer>	6/6	Indicate the source of media stream. 0 means the first stream. 1 means the second stream and etc.
weekday	<interger>	6/6	Indicate which weekday is scheduled. One bit represents one weekday. The bit0 (LSB) indicates Saturday. The bit1 indicates Friday. The bit2 indicates Thursday. The bit3 indicates Wednesday. The bit4 indicates Tuesday. The bit5 indicates Monday. The bit6 indicates Sunday. For example, to detect events on Friday and Sunday, set weekday as 66.
begintime	hh:mm	6/6	Begin time of weekly schedule.
endtime	hh:mm	6/6	End time of weekly schedule. (00:00~24:00 means always.)
prefix	string[16]	6/6	Indicate the prefix of the filename.
limitsize	0,1	6/6	0: Entire free space mechanism 1: Limit recording size mechanism
cyclesize	16~	6/6	The maximum size for cycle recording in Kbytes when choose limit recording size.
cyclic	0,1	6/6	0: Disable cyclic recording 1: Enable cyclic recording
notify	0,1	6/6	0: Disable recording notification 1: Enable recording notification
notifyserver	0~31	6/6	Indicate which notification server is scheduled. One bit represents one application server (server_i0~i4). The bit0 (LSB) indicates server_i0. The bit1 indicates server_i1. The bit2 indicates server_i2. The bit3 indicates server_i3. The bit4 indicates server_i4. For example, enable server_i0, server_i2 and server_i4 to be notification server. The notifyserver value is 21.
clearamount	10~	6/6	The clear amount in Mbytes when choose cyclic recording mechanism.

reserveamount	15~	6/6	The reserve amount in Mbytes when choose cyclic recording mechanism.
dest	cf, 0~4	6/6	The destination to store the recording data. "cf" means CF card. "0~4" means the index of network storage.
cffolder	string[128]	6/6	folder name.

Group: **custom\_i<0~2>**

PARAMETER	VALUE	SECURITY (get/set)	DESCRIPTION
name	string[40]	6/6	The identification of customize event script file.

Group: **path**

NAME	VALUE	SECURITY (get/set)	DESCRIPTION
encoder1_start	<boolean>	7/7	Specify the http push server is active for stream 1
encoder2_start	<boolean>	7/7	Specify the http push server is active for stream 2

Group: **https** (product dependent)

NAME	VALUE	SECURITY (get/set)	DESCRIPTION
connect	1025 ~ 65535	7/7	Specify the stunnel connect port
enable	<boolean>	6/6	To enable or disable this secure http
policy	<Boolean>	6/6	If the value is 1, it will force http connection redirect to https connection
method	auto, manual, install	6/6	auto => Create self-signed certificate automatically manual => Create self-signed certificate manually install => Create certificate request and install
status	-2 ~ 1	6/6	Specify the https status. -2=>invalid public key -1=>waiting for certificated 0=>not installed 1=>active
countryname	string[2]	6/6	country name in certificate information
stateorprovince name	string[128]	6/6	state or province name in in certificate information



localityname	string[128]	6/6	the locality name in certificate information
organizationname	string[64]	6/6	organization name in certificate information
unit	string[32]	6/6	organizational unit name in certificate information
commonname	string[64]	6/6	common name in certificate information
validdays	0 ~ 9999	6/6	certification valid period

## Query status of the digital input

**Note:** This request requires the privilege of viewer.

**Method:** GET/POST

Syntax:

```
http://<servername>/cgi-bin/dido/getdi.cgi?[di0]
```

If no parameter is specified, all the status of digital input will be returned.

Return:

```
HTTP/1.0 200 OK\r\n
Content-Type: text/plain\r\n
Content-Length: <length>\r\n
\r\n
[di0=<state>]\r\n
```

where <state> can be 0 or 1.

**Example:** Query the status of digital input 1

Request:

```
http://myserver/cgi-bin/dido/getdi.cgi?di0
```

Response:

```
HTTP/1.0 200 OK\r\n
Content-Type: text/plain\r\n
Content-Length: 7\r\n
\r\n
di0=1\r\n
```

## Capture single snapshot

**Note:** This request require normal user privilege

**Method:** GET/POST

Syntax:

```
http://<servername>/cgi-bin/viewer/video.jpg?[channel=<value>][&resolution=<value>]
[&quality=<value>]
```

If the user requests the size larger than all stream setting on the server, this request will failed!

PARAMETER	VALUE	DEFAULT	DESCRIPTION
<b>channel</b>	0~(n-1)	0	the channel number of video source
<b>resolution</b>	<available resolution>	0	The resolution of image
<b>quality</b>	1~5	3	The quality of image

Server will return the most up-to-date snapshot of selected channel and stream in JPEG format. The size and quality of image will be set according to the video settings on the server.

Return:

```
HTTP/1.0 200 OK\r\n
Content-Type: image/jpeg\r\n
[Content-Length: <image size>\r\n]

<binary JPEG image data>
```

## Account management

**Note:** This request requires administrator privilege

**Method:** GET/POST

Syntax:

```
http://<servername>/cgi-bin/admin/editaccount.cgi?
method=<value>&username=<name>[&userpass=<value>][&privilege=<value>]
[&privilege=<value>][...][&return=<return page>]
```

PARAMETER	VALUE	DESCRIPTION
method	Add	Add an account to server. When using this method, "username" field is necessary. It will use default value of other fields if not specified.
	Delete	Remove an account from server. When using this method, "username" field is necessary, and others are ignored.
	edit	Modify the account password and privilege. When using this method, "username" field is necessary, and other fields are optional. If not specified, it will keep original settings.
username	<name>	The name of user to add, delete or edit
userpass	<value>	The password of new user to add or that of old user to modify. The default value is an empty string.
privilege	<value>	The privilege of user to add or to modify.
	viewer	viewer's privilege
	operator	operator's privilege
	admin	administrator's privilege
return	<return page>	Redirect to the page <return page> after the parameter is assigned. The <return page> can be a full URL path or relative path according the the current path. If you omit this parameter, it will redirect to an empty page.

## System logs

**Note:** This request require administrator privilege

**Method:** GET/POST

Syntax:

```
http://<servername>/cgi-bin/admin/syslog.cgi
```

Server will return the up-to-date system log.

Return:

```
HTTP/1.0 200 OK\r\n
Content-Type: text/plain\r\n
Content-Length: <syslog length>\r\n
```

```
\r\n
<system log information>\r\n
```

## Upgrade firmware

**Note:** This request requires administrator privilege

Method: POST

Syntax:

```
http://<servername>/cgi-bin/admin/upgrade.cgi
```

### Post data:

```
fimage=<file name>[&return=<return page>]\r\n
\r\n
<multipart encoded form data>
```

Server will accept the upload file named <file name> to be upgraded the firmware and return with <return page> if indicated.

## System Information

**Note:** This request requires normal user privilege (**obsolete**)

**Method:** GET/POST

Syntax:

```
http://<servername>/cgi-bin/sysinfo.cgi
```

Server will return the system information. In HTTP API version 2, the CapVersion will be 0200. All the fields in the previous version (0100) is obsolete. Please use "getparam.cgi?capability" instead.

Return:

```
HTTP/1.0 200 OK\r\n
Content-Type: text/plain\r\n
Content-Length: <system information length>\r\n
\r\n
Model=<model name of server>\r\n
```

```
CapVersion=0200\r\n
```

PARAMETER(supported capability version)	VALUE	DESCRIPTION
Model	system.firmwareversion	Model name of server. Ex:IP3133-VVTK-0100a
CapVersion	MMmm, MM is major version from 00 ~ 99 mm is minor version from 00 ~ 99 ex: 0100	The capability field version

## IP filtering

**Note:** This request requires administrator access privilege

**Method:** GET/POST

Syntax:

```
http://<servername>/cgi-bin/admin/ipfilter.cgi?
method=<value>&[start=<ipaddress>&end=<ipaddress>][&index=<value>]
[&return=<return page>]
```

PARAMETER	VALUE	DESCRIPTION
Method	addallow	Add a set of allow IP address range to server. Start and end parameters must be specified. If the index parameter is specified, it will try to add starting from index position.
	adddeny	Add a set of deny IP address range to server. Start and end parameters must be specified. If the index parameter is specified, it will try to add starting from index position.
	deleteallow	Remove a set of allow IP address range from server. If start and end parameters are specified, it will try to remove the matched IP address. If index is specified, it will try to remove the address from given index position. [start, end] parameters have higher priority than the [index] parameter.

	deletedeny	Remove a set of deny IP address range from server. If start and end parameters are specified, it will try to remove the matched IP address. If index is specified, it will try to remove the address from given index position. [start, end] parameters have higher priority than the [index] parameter.
start	<ip address>	The start IP address to add or to delete.
end	<ip address>	The end IP address to add or to delete.
index	<value>	The start position to add or to delete.
return	<return page>	Redirect to the page <return page> after the parameter is assigned. The <return page> can be a full URL path or relative path according to the current path. If you omit this parameter, it will redirect to an empty page.

## Event/Control HTTP tunnel channel

**Note:** This request requires **admin** privilege

**Method:** GET and POST

Syntax:

```
http://<servername>/cgi-bin/admin/ctrlevent.cgi
```

```
-----
```

```
GET /cgi-bin/admin/ctrlevent.cgi
```

```
x-sessioncookie: string[22]
```

```
accept: application/x-vvtk-tunnelled
```

```
pragma: no-cache
```

```
cache-control: no-cache
```

```
-----
```

```
POST /cgi-bin/admin/ ctrlevent.cgi
```

```
x-sessioncookie: string[22]
```

```
content-type: application/x-vvtk-tunnelled
```

```
pragma : no-cache
```

```
cache-control : no-cache
```

```
content-length: 32767
```

```
expires: Sun, 9 Jan 1972 00:00:00 GMT
```

User must use GET and POST to establish two channels for downstream and upstream. The x-sessioncookie in the GET and POST should be the same to be recognized as a pair for one session. The contents of

upstream should be base64 encoded to be able to pass through some proxy server.

This channel will help to do real-time event notification and control. The event and control format are described in another document.

## Get SDP of Streamings

**Note:** This request requires viewer access privilege

**Method:** GET/POST

Syntax:

```
http://<servername>/<network_rtsp_s<0~m-1>_accessname>
```

"m" is the stream number.

"network\_accessname\_<0~(m-1)>" is the accessname for stream "1" to stream "m". Please refer to the "subgroup of network: rtsp" for setting the accessname of SDP.

You can get the SDP by HTTP GET method.

## Open the network streamings

**Note:** This request requires viewer access privilege

Syntax:

For http push server (mjpeg):

```
http://<servername>/<network_http_s<0~m-1>_accessname>
```

For rtsp (mp4), user needs to input the url below for a rtsp compatible player.

```
rtsp://<servername>/<network_rtsp_s<0~m-1>_accessname>
```

"m" is the stream number.

For detailed streaming protocol, please refer to "control signaling" and "data format" documents.

# Technical Specifications

## Specifications

System	<ul style="list-style-type: none"> <li>· CPU: WTK-1000 SoC</li> <li>· Flash: 8 MB</li> <li>· RAM: 32 MB</li> <li>· Embedded OS: Linux 2.4</li> </ul>
Lens	<ul style="list-style-type: none"> <li>· Board lens, dual-band, f= 4.0 mm, F1.8, Fixed</li> <li>· IR corrected</li> </ul>
Angle of View	<ul style="list-style-type: none"> <li>· 56° (horizontal)</li> <li>· 42° (vertical)</li> <li>· 71° (diagonal)</li> </ul>
Shutter Time	<ul style="list-style-type: none"> <li>· 1/5 sec. to 1/15000 sec.</li> </ul>
Image Sensor	<ul style="list-style-type: none"> <li>· 1/4" CMOS sensor in VGA resolution</li> </ul>
Minimum Illumination	<ul style="list-style-type: none"> <li>· 0 Lux / F1.8 (IR LED on)</li> </ul>
IR Illuminators	<ul style="list-style-type: none"> <li>· IR LED x 12 (850 nm)</li> <li>· Effective up to 10 meters</li> </ul>
Video	<ul style="list-style-type: none"> <li>· Compression: MJPEG &amp; MPEG-4</li> <li>· Streaming:                             <ul style="list-style-type: none"> <li>· Simultaneous dual-stream</li> <li>· MPEG-4 streaming over UDP, TCP, HTTP, or HTTPS</li> <li>· MPEG-4 multicast streaming</li> <li>· MJPEG streaming over HTTP or HTTPS</li> </ul> </li> <li>· Supports 3GPP mobile surveillance</li> <li>· Frame rates:                             <ul style="list-style-type: none"> <li>· MPEG-4: 640x480 up to 30/25fps</li> <li>· MJPEG: 640x480 up to 30/25fps</li> </ul> </li> </ul>
Image Settings	<ul style="list-style-type: none"> <li>· Adjustable image size, quality, and bit rate</li> <li>· Time stamp and text caption overlay</li> <li>· Flip &amp; mirror</li> <li>· Configurable brightness, saturation contrast, sharpness and white balance</li> <li>· AGC, AES</li> <li>· Automatic, manual or scheduled day/night mode</li> <li>· Supports privacy masks</li> </ul>
Networking	<ul style="list-style-type: none"> <li>· 10/100 Mbps Ethernet, RJ-45</li> <li>· Protocols: IPv4, TCP/IP, HTTP, HTTPS, UPnP, RTSP/RTP/RTCP, IGMP, SMTP, FTP, DHCP, NTP, DNS, DDNS, and PPPoE</li> </ul>
Alarm and Event Management	<ul style="list-style-type: none"> <li>· Triple-window video motion detection</li> <li>· Tamper detection</li> <li>· One D/I for external sensor</li> <li>· Event notification using HTTP, SMTP, or FTP</li> <li>· Local recording of MP4 file</li> </ul>
Security	<ul style="list-style-type: none"> <li>· Multi-level user access with password protection</li> <li>· IP address filtering</li> <li>· HTTPS encrypted data transmission</li> </ul>
Users	<ul style="list-style-type: none"> <li>· Camera live viewing for up to 5 clients</li> </ul>
Dimension	<ul style="list-style-type: none"> <li>· Ø59.4 mm x 150 mm</li> </ul>
Weight	<ul style="list-style-type: none"> <li>· Net: 630 g</li> </ul>
LED Indicator	<ul style="list-style-type: none"> <li>· System restore status indicator</li> </ul>
Power	<ul style="list-style-type: none"> <li>· 12V DC</li> <li>· 24V AC</li> <li>· Power consumption: Max. 4 W with IR LED on</li> <li>· 802.3af compliant Power-over-Ethernet</li> </ul>
Housing	<ul style="list-style-type: none"> <li>· Weather-proof IP66-rated housing</li> </ul>
Approvals	<ul style="list-style-type: none"> <li>· CE, LVD, FCC, VCCI, C-Tick</li> </ul>

Operating Environments	<ul style="list-style-type: none"> <li>· Temperature: -20 ~ 50 °C (-4 ~ 122 °F)</li> <li>· Humidity: 90% RH</li> </ul>
Viewing System Requirements	<ul style="list-style-type: none"> <li>· OS: Microsoft Windows 2000/XP/Vista</li> <li>· Browser: Internet Explorer 6.x or above</li> <li>· Cell phone: 3GPP player</li> <li>· Real Player 10.5 or above</li> <li>· Quick Time 6.5 or above</li> </ul>
Installation, Management, and Maintenance	<ul style="list-style-type: none"> <li>· Installation Wizard 2</li> <li>· 16-CH recording software</li> <li>· Supports firmware upgrade</li> </ul>
Applications	<ul style="list-style-type: none"> <li>· SDK available for application development and system integration</li> </ul>
Warranty	<ul style="list-style-type: none"> <li>· 12 months</li> </ul>

### System Overview

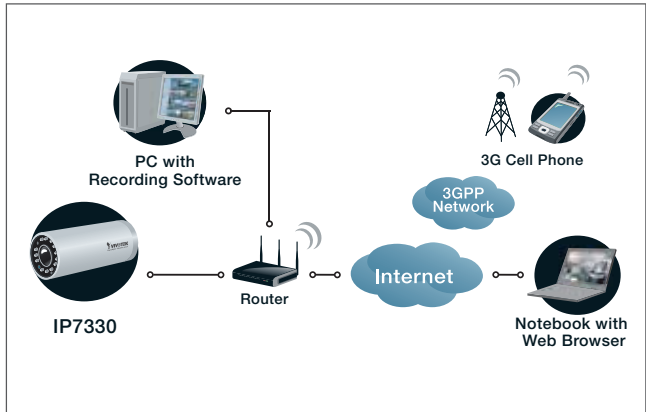

### External View

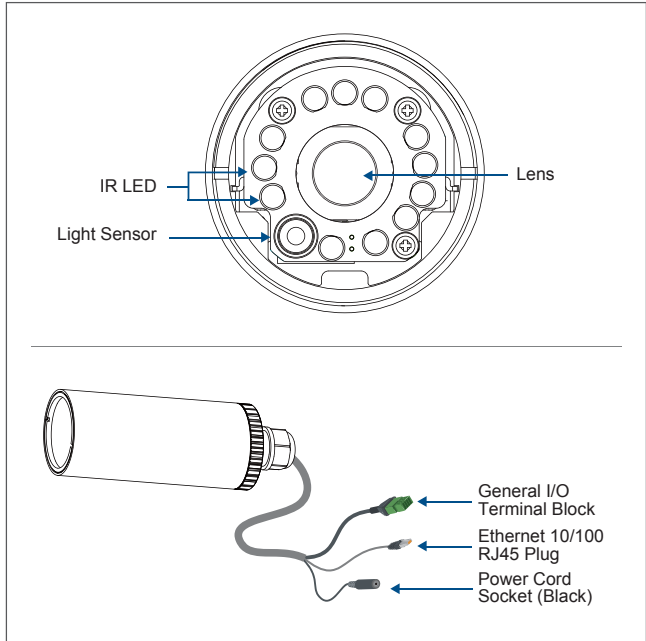

All specifications are subject to change without notice. Copyright ©2009 VIVOTEK INC. All rights reserved.



## Technology License Notice

### MPEG-4 AAC Technology

THIS PRODUCT IS LICENSED UNDER THE MPEG-4 AAC AUDIO PATENT LICENSE. THIS PRODUCT MAY NOT BE DECOMPILED, REVERSE-ENGINEERED OR COPIED, EXCEPT REGARD TO PC SOFTWARE, YOU MAY MAKE SINGLE COPIES FOR ARCHIVAL PURPOSES. FOR MORE INFORMATION, PLEASE REFER TO [HTTP://WWW.VIALICENSING.COM](http://www.vialicensing.com).

### MPEG-4 Visual Technology

THIS PRODUCT IS LICENSED UNDER THE MPEG-4 VISUAL PATENT PORTFOLIO LICENSE FOR THE PERSONAL AND NON-COMMERCIAL USE OF A CONSUMER FOR (i) ENCODING VIDEO IN COMPLIANCE WITH THE MPEG-4 VISUAL STANDARD ("MPEG-4 VIDEO") AND/OR (ii) DECODING MPEG-4 VIDEO THAT WAS ENCODED BY A CONSUMER ENGAGED IN A PERSONAL AND NON-COMMERCIAL ACTIVITY AND/OR WAS OBTAINED FROM A VIDEO PROVIDER LICENSED BY MPEG LA TO PROVIDE MPEG-4 VIDEO. NO LICENSE IS GRANTED OR SHALL BE IMPLIED FOR ANY OTHER USE. ADDITIONAL INFORMATION INCLUDING THAT RELATING TO PROMOTIONAL, INTERNAL AND COMMERCIAL USES AND LICENSING MAY BE OBTAINED FROM MPEG LA, LLC. PLEASE REFER TO [HTTP://WWW.MPEGLA.COM](http://www.mpeg-la.com).

### AMR-NB Standard

THIS PRODUCT IS LICENSED UNDER THE AMR-NB STANDARD PATENT LICENSE AGREEMENT. WITH RESPECT TO THE USE OF THIS PRODUCT, THE FOLLOWING LICENSORS' PATENTS MAY APPLY:

TELEFONAKIEBOLAGET ERICSSON AB: US PAT. 6192335; 6275798; 6029125; 6424938; 6058359. NOKIA CORPORATION: US PAT. 5946651; 6199035. VOICEAGE CORPORATION: AT PAT. 0516621; BE PAT. 0516621; CA PAT. 2010830; CH PAT. 0516621; DE PAT. 0516621; DK PAT. 0516621; ES PAT. 0516621; FR PAT. 0516621; GB PAT. 0516621; GR PAT. 0516621; IT PAT. 0516621; LI PAT. 0516621; LU PAT. 0516621; NL PAT. 0516621; SE PAT. 0516621; US PAT. 5444816; AT PAT. 819303/AT E 198805T1; AU PAT. 697256; BE PAT. 819303; BR PAT. 9604838-7; CA PAT. 2216315; CH PAT. 819303; CN PAT. ZL96193827.7; DE PAT. 819303/DE69611607T2; DK PAT. 819303; ES PAT. 819303; EP PAT. 819303; FR PAT. 819303; GB PAT. 819303; IT PAT. 819303; JP PAT. APP. 8-529817; NL PAT. 819303; SE PAT. 819303; US PAT. 5664053. THE LIST MAY BE UPDATED FROM TIME TO TIME BY LICENSORS AND A CURRENT VERSION OF WHICH IS AVAILABLE ON LICENSOR'S WEBSITE AT [HTTP://WWW.VOICEAGE.COM](http://www.voiceage.com).

## Electromagnetic Compatibility (EMC)

### FCC Statement

This device complies with FCC Rules Part 15. Operation is subject to the following two conditions.

- This device may not cause harmful interference, and
- This device must accept any interference received, including interference that may cause undesired operation.

This equipment has been tested and found to comply with the limits for a Class A digital device, pursuant to Part 15 of the FCC Rules. These limits are designed to provide reasonable protection against harmful interference when the equipment is operated in a commercial environment. This equipment generates, uses, and can radiate radio frequency energy and, if not installed and used in accordance with the installation manual, may cause harmful interference to radio communications. Operation of this equipment in a residential area is likely to cause harmful interference, in which case the user will be required to correct the interference at his own expense.

### CE Mark Warning

This is a Class A product. In a domestic environment, this product may cause radio interference, in which case the user may be required to take adequate measures.

### Liability

VIVOTEK Inc. cannot be held responsible for any technical or typographical errors and reserves the right to make changes to the product and manuals without prior notice. VIVOTEK Inc. makes no warranty of any kind with regard to the material contained within this document, including, but not limited to, the implied warranties of merchantability and fitness for any particular purpose.